

This Page Is Inserted by IFW Operations
and is not a part of the Official Record

BEST AVAILABLE IMAGES

Defective images within this document are accurate representations of the original documents submitted by the applicant.

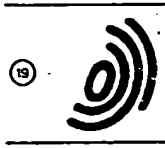
Defects in the images may include (but are not limited to):

- BLACK BORDERS
- TEXT CUT OFF AT TOP, BOTTOM OR SIDES
- FADED TEXT
- ILLEGIBLE TEXT
- SKEWED/SLANTED IMAGES
- COLORED PHOTOS
- BLACK OR VERY BLACK AND WHITE DARK PHOTOS
- GRAY SCALE DOCUMENTS

IMAGES ARE BEST AVAILABLE COPY.

**As rescanning documents *will not* correct images,
please do not report the images to the
Image Problem Mailbox.**

CR



Europäisches Patentamt
European Patent Office
Office européen des brevets



Publication number: **0 451 700 A1**

EUROPEAN PATENT APPLICATION **49**

Application number: 91105332.0 Int. Cl.⁵: C12N 15/00, C12N 15/12
Date of filing: 04.04.91

Priority: 10.04.90 US 507705
 20.02.91 US 656248
Date of publication of application:
16.10.91 Bulletin 91/42
Designated Contracting States:
AT BE CH DE DK ES FR GB GR IT LI LU NL SE

Applicant: MILES INC.
1127 Myrtle Street
Elkhart, IN 46515(US)
Inventor: Wirak, Dana O.
168 Haverford Street
Hamden, CT 06517(US)
Inventor: Bayney, Richard
96 Strathmore Avenue
Milford, CT 06460(US)
Inventor: Ramabhadran, Triprayer V.
112 Murray Lane
Gulford, CT 06437(US)
Inventor: Unterbeck, Axel
Rommerscheider Höhe 3
W-5060 Bergisch-Gladbach 2(DE)
Inventor: Rae, Peter
Am Oberen Werth 27
W-4000 Düsseldorf(DE)
Inventor: Scangos, George
Waldsee Strasse
W-4030 Ratingen(DE)
Representative: Dänner, Klaus, Dr. et al
c/o Bayer AG Konzernverwaltung RP
Patentabteilung
W-5090 Leverkusen 1 Bayerwerk(DE)

Recombinant APP minigenes for expression in transgenic mice as models for Alzheimer's disease.

Functional recombinant APP minigene constructs and their introduction into the germline of transgenic mice. Such transgenic mice are useful to generate models of Alzheimer's disease and pathogenesis and are also useful to identify molecular mechanisms of the pathogenesis of Alzheimer's disease.

EP 0 451 700 A1

BACKGROUND OF THE INVENTION

This invention relates to recombinant gene constructs, minigene constructs, and transgenic mice for phenotypic expression of Alzheimer-like pathology. The invention further relates to transgenic animal models for Alzheimer's disease. In particular, the present invention provides a variety of minigene constructs which include all or portions of the coding sequences of the amyloid precursor proteins, and which can be expressed in a cell and tissue in a specific manner in transgenic mice carrying the minigene constructs.

Alzheimer's disease (AD) is the most common single cause of dementia in late life. Individuals with AD are characterized by progressive memory impairments, loss of language and visuospatial skills and behavior deficits (McKhann et al., 1986, *Neurology* 34: 939-944). The cognitive impairment of individuals with AD is the result of degeneration of neuronal cells located in the cerebral cortex, hippocampus, basal forebrain and other brain regions (for reviews, see Kemper, in *Clin. Neurol. Aging*, M.L. Albert, ed., pp. 9-52, Oxford University Press, New York, 1984; Price, 1986, *Annu. Rev. Neurosci.* 9: 489-512). Histologic analyses of AD brains obtained at autopsy demonstrated the presence of neurofibrillary tangles (NFT) in perikarya and axons of degenerating neurons, extracellular neuritic (senile) plaques, and amyloid plaques inside and around some blood vessels of affected brain regions (Alzheimer, 1907, *Allg. Z. Psychiat. u. Psych. Gerichtl. Med.* 64: 146-148). Neurofibrillary tangles are abnormal filamentous structures containing fibers (about 10 nm in diameter) that are paired in a helical fashion, therefore also called paired helical filaments (Kidd, 1963, *Nature* 197: 192-193; Wisniewski et al., 1976, *J. Neurol. Sci.* 27: 173-181; Selkoe et al., 1982, *Science* 215: 1243-1245; Brion et al., 1985, *J. Submicrosc. Cytol.* 17: 89-96; Grundke-Iqbal et al., 1986, *J. Biol. Chem.* 261: 6084-6089; Wood et al., 1986, *Proc. Natl. Acad. Sci. USA* 83: 4040-4043; Kosik et al., 1986, *Proc. Natl. Acad. Sci. USA* 83: 4044-4048; Goedert et al., 1988, *Proc. Natl. Acad. Sci. USA* 85: 4051-4055; Wischik et al., 1988a, *Proc. Natl. Acad. Sci. USA* 85: 4884-4888; Wischik et al., 1988b, *Proc. Natl. Acad. Sci. USA* 85: 4506-4510). Neuritic plaques are located at degenerating nerve terminals (both axonal and dendritic), and contain a core composed of amyloid protein fibers (Masters et al., 1985a, *EMBO J.* 4: 2757-2763; Masters et al., 1985b, *Proc. Natl. Acad. Sci. USA* 82: 4245-4249). Cerebrovascular amyloid protein material is found in blood vessels in the meninges and the cerebral cortex (Glenner and Wong, 1984a, *Biochem. Biophys. Res. Commun.* 120: 885-890; Glenner and Wong, 1984b, *Biochem. Biophys. Res. Commun.* 122: 1131-1135; Wong et al., 1985, *Proc. Natl. Acad. Sci. USA* 82: 8729-8732).

During the past several years, primary pathological markers associated with AD have been characterized. The biochemical analyses of three forms of Alzheimer brain lesions (for reviews, see Kemper, *supra*; Wurtman, 1985, *Sci. Amer.* 252: 62-74; Katzman, 1986, *N. Engl. J. Med.* 314: 964-973; Price, 1986, *supra*; Selkoe, 1989, *Ann. Rev. Neurosci.* 12: 463-490; Muller-Hill and Beyreuther, 1989, *Ann. Rev. Biochem.* 58: 287-307), tangles, neuritic plaques, and cerebrovascular plaques, has revealed protein sequence information, and has facilitated subsequent cDNA cloning and chromosomal mapping of some of the corresponding genes. Immunological studies have identified several candidates for protein constituents of the paired helical filaments (PHF), including microtubule-associated protein 2 (MAP-2), tau, ubiquitin and the amyloid protein (A4). Degenerating nerve cells express specific antigens such as A68, a 68 kDa protein. This abnormal antigen is detectable with the monoclonal antibody ALZ-50 (Wolozin et al., 1986, *Science* 232: 648-650; Wolozin et al., 1987, *Ann. Neurol.* 22: 521-526; Wolozin et al., 1988, *Proc. Natl. Acad. Sci. USA* 85: 6202-6206).

A central feature of the pathology of AD is the deposition of amyloid protein within plaques. The 4 kDa amyloid protein (also referred to as A4 (APC, β -amyloid or BAP) is a truncated form of the larger amyloid precursor protein (APP) which is encoded by a gene localized on chromosome 21 (Goldgaber et al., 1987, *Science* 235: 877-880; Kang et al., 1987, *Nature* 325: 733-736; Jenkins et al., 1988, *Biochem. Biophys. Res. Commun.* 151: 1-8; Tanzi et al., 1987, *Science* 235: 880-885). Genetic linkage analysis, using DNA probes that detect restriction fragment-length polymorphisms (RFLPs, Botstein et al., 1980, *Am. J. Hum. Genet.* 32: 314-331), has resulted in the localization of a candidate gene (FAD, familial AD) on human chromosome 21 in families with high frequencies of AD (St. George-Hyslop et al., 1987a, *Science* 235: 885-890). However, the FAD locus has not been localized precisely, and very little is known about its function. Initial studies of individuals with Down syndrome (DS), caused by trisomy of part or all of chromosome 21, indicate that these individuals develop Alzheimer-like pathology beyond the second decade of life. However, analysis of multiple Alzheimer pedigrees revealed that the APP gene does not segregate with familial AD (Van Broeckhoven et al., 1987, *Nature* 328: 153-155; Tanzi et al., 1987, *Nature* 329: 156-157). Furthermore, two recent studies with new families demonstrated the absence of a linkage of chromosome 21 markers to familial AD (Schellenberg et al., 1988, *Science* 241: 1507-1510; Roses et al., 1988, *Neurology* 38: 173).

Age, genetic elements, and possibly environmental factors appear to contribute to cellular pathology of

AD. A fundamental but unanswered question in the pathogenesis of AD is the relationship between abnormalities of neurons and the deposition of amyloid. Specifically, the cellular origin of pathological events leading to the deposition of amyloid fibrils adjacent to some areas of the blood-brain barrier (cerebrovascular amyloid) and in the proximity of nerve terminals (neuritic plaques) in specific brain regions as well as extracellular amyloid in plaque cores is not known. Glenner and Wong have described the purification and characterization of meningeal amyloid from both brains of individuals with AD (Glenner and Wong, 1984a, *supra*) or DS (Glenner and Wong, 1984b, *supra*) and determined the N-terminal peptide sequences. Among 24 residues analyzed, the two amyloid peptides showed only one difference, namely, at amino acid position 11 (glutamine in AD amyloid versus glutamic acid in DS amyloid) among 24 residues analyzed. Subsequent studies of amyloid from Alzheimer brain plaque cores revealed amino acid sequences identical to the reported DS cerebrovascular amyloid data (Masters et al. 1985b, *Proc. Natl. Acad. Sci. USA* 82: 4245-4249). Copy-DNA analysis of APP transcripts from both normal tissue and Alzheimer brain material demonstrated the presence of the codon for glutamic acid at this position (Kang et al., 1987, *supra*; Goldgaber et al., 1987, *supra*; Robakis et al., 1987, *Lancet*: 384-385; Tanzi et al., 1987, *Science* 235: 880-884; Zain et al., 1988, *Proc. Natl. Acad. Sci. USA* 85: 929-933; Vitek et al., 1988, *Mol. Brain Res.* 4: 121-131).

The availability of protein sequence information from the amyloid protein in Alzheimer brains enabled the design of synthetic oligonucleotides complementary to the putative messenger RNA transcripts. Four groups independently reported successful cloning of cDNAs including the region of the amyloid protein sequence (Goldgaber et al., 1987, *supra*; Kang et al., 1987, *supra*; Robakis et al., *supra*; Tanzi et al., 1987, *supra*). One group (Kang et al.) cloned the apparent full-length transcript (approximately 3.4 kb) for APP from a human fetal brain cDNA library. The 695-residue amyloid precursor protein (APP-695) shows typical features of a glycosylated cell-surface transmembrane protein. The C-terminal 12 to 14 residues of the A4 protein reside in the putative transmembrane domain of the precursor and 28 N-terminal residues are in the "extracellular domain" (Dyrks et al., 1988, *EMBO J.* 7: 949-957). Genomic mapping localized the APP gene on human chromosome 21 using human/rodent somatic cell hybrids (Goldgaber et al., 1987, *supra*; Kang et al., 1987, *supra*; Tanzi et al., 1987, *supra*). Applying *in situ* hybridization techniques, this gene was sublocalized to chromosome 21q21 (Robakis et al., *supra*) and more recently at the border of 21q21-22 (Blanquet et al., 1987, *Ann. Genet.* 30: 68-69; Patterson et al., 1988, *Proc. Natl. Acad. Sci. USA* 85: 8266-8270).

Chromosome 21 has been the subject of intensive studies because of its involvement in DS (trisomy 21). While 95% of individuals with DS are trisomic for the entire chromosome 21, 2-3% are mosaics, i.e., trisomic in only some cells, and 3-4% are caused by triplication (translocation) of the distal part of the long arm (21q22) of chromosome 21 (Crome and Stern, 1972, *Pathology of Mental Retardation*, Churchill Livingstone, Edinburgh). The occurrence of such translocations has led to the conclusion that DS can be attributed to trisomy of the distal part (the "pathological region") of chromosome 21 (Summitt, 1981, in *Trisomy 21 (Down Syndrome): Research Perspectives*, de la Cruz and Gerald, eds., pp. 225-235, University Park Press, Baltimore). To date, it is not known precisely where the breakpoint on the q arm of chromosome 21 is located, and it is not known whether individuals with DS, who have partial trisomy, develop Alzheimer pathology. In this context, it will be of particular interest to determine if the APP gene maps within the "pathological region" of chromosome 21. The localization of the APP gene on the long arm of chromosome 21, together with the apparent development of AD pathology in individuals with DS, provides a potential mechanism for the formation of amyloid on the basis of over-expression of a number of genes on chromosome 21, including the APP gene and the FAD gene locus. Initial studies of genomic DNA from sporadic (non-familial) AD cases and "karyotypically normal" individuals with DS have implicated the presence of microduplication of a segment of chromosome 21 including the APP gene (Delabar et al., 1987, *Science* 235: 1390-1392; Schweber et al., 1987, *Neurology* 37: 222). However, subsequent analyses of large numbers of individuals with AD by several laboratories has not confirmed these findings (Tanzi et al., 1987c, *Science* 238: 666-669; St. George-Hyslop et al., 1987b, *Science* 238: 664-666; Podlisny et al., 1987, *Science* 238: 869-871; Warren et al., 1987, *Genomics* 1: 307-312).

Chromosomal mapping experiments, using human APP probes in human/rodent cell hybrids, have shown cross-hybridization with mouse and hamster genomic DNA (Kang et al., 1987, *supra*; Tanzi et al., 1987a, *supra*; Goldgaber et al., 1987, *supra*). Southern-blot analysis of DNA from various species has indicated that the APP gene is highly conserved during evolution. Comparison of the mouse APP sequence (Yamada et al., 1987, *Biochem. Biophys. Res. Commun.* 158: 906-912) with the sequence from rat (Shivers et al., 1988, *EMBO J.* 7: 1365-1370) shows 99% homology on the protein level; furthermore, the human sequence is 96.8% homologous to the mouse sequence and 97.3% homologous to the rat sequence. Based on the striking conservation of APP proteins, Yamada et al., *supra*, have calculated the evolutionary

rate of changes at the amino acid level to be 0.1×10^{-3} /site/year, which is comparable to that of cytochrome C, and suggests an essential biological function for APP proteins. Recently, K. White and colleagues have cloned a *Drosophila* gene (*vnd* locus) which is highly homologous to large regions of the APP sequence. Northern-blot experiments have confirmed these data at the level of mRNA and have demonstrated for various mammalian species the ubiquitous expression of APP transcripts in a number of different tissues (Manning et al., 1988, *Brain Res.* 427: 293-297).

Kang et al., *supra*, reported the presence of two distinct bands (~3.2 kb and ~3.4 kb) by Northern-blot analysis of human fetal brain mRNA using APP cDNA as a probe. This finding suggests either differential splicing of mRNA or alternative usage of polyadenylation sites. Both post-transcriptional events were found to be operative following detailed investigation by several groups. First, Kang et al., *supra*, indicated a potential polyadenylation signal (AATAAA tandem repeat) 259 bp upstream of the 3'-end of the reported APP full-length cDNA. The analysis of eight other full-length APP cDNA clones obtained from a human fetal brain cDNA library (Unterbeck, 1986, Dissertation, University Cologne, FRG) demonstrated in a 1:1 ratio between shorter cDNAs (~3.2 kb) using the first polyadenylation signal versus the original cDNA forms (~3.4 kb) using the second polyadenylation signal. Interestingly, all eight clones encoded for 695 residues of APP. The alternative use of different polyadenylation signals in APP transcripts was confirmed by other laboratories (Goldgaber, 1988, in *The Molecular Biology of Alzheimer's Disease*, Finch and Davis, eds., pp. 66-70, Cold Spring Harbor Laboratory, Cold Spring Harbor, New York; Johnson et al., 1988, *Exp. Neurol.* 102: 264-268). A number of groups have screened several tumour cell-line derived cDNA libraries for the presence of APP transcripts and identified clones encoding new APP molecules containing an additional domain. This domain possesses striking homology to the Kunitz family of serine protease inhibitors (Tanzi et al., 1988, *Nature* 351: 528-530; Ponte et al., 1988, *Nature* 331: 525-527; Kitaguchi et al., 1988, *Nature* 331: 530-532). In particular these cDNA sequences contain an additional 167 bp insert at residue 289 of the APP-695 precursor (SEQ ID NO:42/43) (Figure 1) which encodes a 56 amino acid sequence of high sequence of homology to aprotinin (Laskowski and Kato, 1980, *Ann. Rev. Biochem.* 49: 593-626), a well-characterized inhibitor of "trypsin-like" serine proteases. The peptide sequences flanking this region of insert are identical to the original APP-695 clone, resulting in an open reading frame of 751 residues (APP-751). Kitaguchi et al., *supra*, isolated a third APP form with another addition of a 19 amino acid domain at the C-terminal end of the 56 amino acid "aprotinin-like" region of APP-751, thus resulting in a larger protein of 770 residues (APP-770). Transient expression of APP-770 in COS-1 cells conferred a marked inhibition of trypsin activity in cell lysates (Kitaguchi et al., *supra*). Both additional domains have been found to be encoded by discrete exons (Kitaguchi et al., *supra*) and all three transcripts (APP-695, APP-751, APP-770) are generated by differential splicing of a single gene on chromosome 21. These protease inhibitor domains have also recently been found to be present in mouse (Yamada et al., 1989, *Biochem. Biophys. Res. Commun.* 158: 906-912) and rat (Kang and Muller-Hill, 1989, *Nucleic Acids Res.* 17: 2130) species.

The relationship between the three different amyloid precursor forms and the formation of amyloid in AD is not known. In particular, it is not known whether a specific form of APP contributes to A4 deposition. It is possible that either an imbalance in the relative expression levels of the three APP forms or their over-expression might be involved in AD pathology. Initial *in situ* hybridization analyses using APP cDNA probes in human CNS sections indicated that many neuronal cell types express these mRNAs (Bahmanyar et al., 1987, *Science* 237: 77-79; Goedert, 1987, *EMBO J.* 6: 3627-3632; Cohen et al., 1988, *Proc. Natl. Acad. Sci. USA* 85: 1227-1231; Higgins et al., 1988, *Proc. Natl. Acad. Sci. USA* 85: 1297-1301; Lewis et al., 1988, *Proc. Natl. Acad. Sci. USA* 85: 1691-1695; Schmechel et al., 1988, *Alzheimer Dis. Assoc. Disord. (US)* 2: 96-111), but because of the nature of the probes used, these studies did not allow a differential analysis of the various APP transcripts. Furthermore, there is little documented correlation between APP mRNA levels, amyloid deposition and neuronal degeneration in AD. However, it appears that high levels of APP mRNAs alone do not form a sufficient prerequisite for cellular pathology in either the aging or AD brain (Higgins et al., *supra*). Specific probes which discriminate between the APP transcripts have been used for Northern analysis and the results suggest a developmental and tissue-specific pattern of expression of these mRNAs (Tanzi et al., 1988, *supra*; Kitaguchi et al., 1988, *supra*; Neve et al., 1988, *Neuron* 1: 669-677).

Recently, 5'-end cDNA probes from full-length APP cDNA clones (Kang et al., 1987, *supra*), have been used to isolate genomic clones containing the 5'-end of the APP gene, also referred to as precursor of Alzheimer's Disease A4 amyloid protein (PAD) gene (Salbaum et al., 1988, *EMBO J.* 7: 2807-2813; La Fauci et al., 1989, *Biochem. Biophys. Res. Commun.* 159: 297-304). Approximately 3.7 kb of sequences upstream of the strongest RNA start site have been analyzed by Salbaum et al., 1988, *supra*. By a combination of primer extension and S1 protection analyses, five putative transcription initiation sites have been determined within a 10 bp region. This ~3.7 kb region lacks a typical TATA box and displays a 72% GC-rich content in a region (-1 to -400) that confers promoter activity to a reporter gene in an *in vivo* assay system (Salbaum

et al., 1988, *supra*). The absence of a typical TATA and CAAT box and the presence of multiple RNA start sites is suggestive of its function as a housekeeping gene but does not imply constitutive gene expression (Salbaum et al., 1988, *supra*). The regulatory region contained within 400 bp upstream of the strongest RNA start site shows a variety of typical promoter-binding elements, including: two AP-1 consensus sites (Lee et al., 1987, *Nature* 325: 368-372), a single heat shock recognition consensus element (Wu et al., 1987, *Science* 238: 1247-1253), and several copies of a 9 bp-long GC-rich consensus sequence where sequence-specific binding has been shown to occur by gel-retardation studies (Salbaum et al., 1988, *supra*). In addition, the CpG:GpC ratio in this promoter region has been found to be 1:1 in contrast to a 1:5 ratio found in many eucaryotic DNAs (Razin and Riggs, 1980, *Science* 210: 604-610); CpG dinucleotides are known to control gene expression via DNA methylation (Doerfler, 1983, *Annu. Rev. Biochem.* 52: 93-124). In addition, palindromic sequences capable of forming hairpin-like structures are found around the RNA start sites (La Fauci et al., 1989, *supra*).

Recently, several groups of investigators have determined the consensus binding sequence (AT rich decamer) for a number of different homeobox proteins (Desplan et al., 1988, *Cell* 54: 1081-1090; Hoey and Levine, 1988, *Nature* 322: 858-861; Ko et al., 1988, *Cell* 55: 135-144; Odenwald et al., 1989, *Genes Dev.* 1: 482-496), which act most likely as transcription factors in specific regions during embryogenesis (for review, see Gehring, 1987, *Science* 236: 1245-1252; Holland and Hogan, 1988, *Genes Dev.* 2: 773-782). As yet, target genes, which might be developmentally regulated by the homeobox proteins have not been identified. Such genes, however, will have an important role during embryogenesis and potentially throughout the entire life span. The APP gene promoter contains at least five homeobox binding sites upstream of the RNA start sites. Preliminary experiments have shown that the homeobox protein Hox-1.3 (Odenwald et al., 1987, *Genes Dev.* 1: 482-496; Odenwald et al., 1989, *Genes Dev.* 3: 158-172) can bind at two of these sites. Thus, the APP gene, whose expression is developmentally regulated, appears to be a candidate gene for homeobox protein regulation. It is not known whether any of these putative recognition consensus elements modulate the expression of the APP gene promoter.

Despite all that is known about the APP gene, the primary defect leading to AD is not yet known, and specific mutations in the APP gene or other genes which cause AD in humans have not been defined. With the exception of aged primates (Price et al., 1989, *BioEssays* 10: 69-74), no laboratory animal model for AD exists. The introduction of genes into the germline of animals is an extremely powerful technique for the generation of disease models which will lead to a better understanding of disease mechanisms (Cuthbertson and Klintworth, 1988, *Laboratory Investigation* 58: 484-501; Jaenisch, 1988, *Science* 240: 1468-1474; Rosenfeld et al., 1988, *Ann. Rev. Neurosci.* 11: 353-372), including the mechanisms of AD. Cell culture and *in vitro* systems cannot duplicate the complex physiological interactions inherent in animal systems. Transgenic animals have been successfully generated from a number of species including mice, sheep, and pigs (Church, 1987, *Trends in Biotech.* 5: 13-19; Clark et al., 1987, *Trends in Biotech.* 5: 20-24). The gene or genes of interest are microinjected directly into the pronuclei of a one-cell embryo. A high percentage of reimplanted embryos develop normally and, in a significant proportion of progeny, the transgene becomes integrated into the chromosomal DNA. Usually, multiple copies of the transgene integrate as a head-to-tail array. Although mosaic animals can be generated, germline transmission of the transgene usually occurs (Hogan et al., 1986, in *Manipulating the Mouse Embryo; A Laboratory Manual*, Cold Spring Harbor Laboratory, Cold Spring Harbor, New York; DePamphilis et al., 1988, *BioTechniques* 6: 682-680). The generation of a transgenic mouse would be useful in defining the role of APP in the pathology of AD. For example, mice carrying APP transgenes which have been altered in either their protein-coding sequences or in their expression levels, might display dominant mutant phenotypes resembling those displayed in AD pathology. The construction of recombinant genes and minigenes for expression in transgenic mice is a critical step in the development of transgenic mouse models. Particularly critical is the choice of an appropriate gene promoter for the minigene and other regulatory elements for the cell and tissue specific expression of the minigene. A gene promoter must be utilized which will facilitate the expression of recombinant genes with a cell and tissue specificity consistent with the formation of amyloid plaque and perhaps with the expression pattern of the endogenous mouse APP gene.

To date, the identification of essential regulatory elements for many genes has not been straightforward and is, at best, unpredictable. A number of critical factors contribute to the complexity of this problem. Firstly, gene promoters that exert cell specific regulation in DNA transfection experiments do not necessarily confer cell and tissue specificity in transgenic animals. For example, transfection experiments have revealed that important cell specific regulatory elements reside within 400 bp upstream of the cap site of the rat albumin gene (Ott et al., 1984, *EMBO J.* 3: 2505-2510; Friedman et al., 1986, *Mol. Cell Biol.* 6: 3791-3797). However, an additional enhancer, located 10 kb upstream from the albumin promoter, was found to be necessary to obtain liver-specific expression in transgenic mice (Pinkert et al., 1987, *Genes Dev.* 1: 268-

276). While promoter sequences of the α -fetoprotein gene confer cell specificity in cell culture (Godbout et al., 1986, Mol. Cell Biol. 6: 477-487; Muglia and Rothman-Denes, 1986, Proc. Natl. Acad. Sci. USA 83: 7653-7657; Widen and Papaconstantinou, 1986, Proc. Natl. Acad. Sci. USA 83: 8196-8200), additional enhancer elements located between -1 kb and -7 kb, were found to be necessary for liver specific expression in transgenic animals (Hammer et al., 1987, Science 235: 53-58). Secondly, the organization of various genes differs considerably and essential regulatory elements have been found in numerous positions. In some cases, the necessary regulatory elements are located within a compact region proximal to the cap site. For example, sequences residing within nucleotide -205 to nucleotide +8 of the rat elastase I gene are sufficient to confer an appropriate expression pattern in transgenic mice (MacDonald et al., 1987, Progress in Brain Research 71: 3-12). A tightly defined regulatory region has also been identified in the human γ -crystallin gene (Göring et al., 1987, Science 235: 456-458). The human β -globin gene, however, has at least four separate regulatory elements: a positive globin specific promoter element, a negative regulatory element, and two gene enhancers, one located within the second intron and the other located 3' of the structural gene (Behringer et al., 1987, Proc. Natl. Acad. Sci. USA 84: 7056-7060; Grosveld et al., 1987, Cell 51: 975-985). Thirdly, in many cases, the site of integration exerts a strong influence on the level and pattern of expression of transgenes. Regions of several genes have been identified which overcome, at least in part, these position effects. DNase I hypersensitive sites located approximately 50 kb 5' to and 20 kb 3' of the β -globin gene facilitate position-independent, high-level expression of a β -globin minigene in transgenic mice (Grosveld et al., 1987, supra). Furthermore, introns of the rat growth hormone and mouse metallothionein genes increase transcriptional efficiency of transgenes on average 10- to 100-fold (Brinster et al., 1988, Proc. Natl. Acad. Sci. USA 85: 836-840). Rat growth hormone intronic sequences exerted a positive effect even on heterologous gene constructions utilizing either the metallothionein or elastase promoters. The effect of these introns is not related to an increased efficiency of RNA processing but is due to an actual increase in the rate of transcription (Brinster et al., 1988, supra). It is also possible that introns and other genomic regions contain sequence elements which are recognized at particular stages of development or may contain elements which influence chromatin structure. In many cases, the inclusion of genomic elements which diminish position effects may be essential for a transgene to maintain an expression level sufficient to generate a phenotype. The identification of these elements may in some cases be a formidable task; for example, the APP gene locus encompasses at least 50 kb (Lemaire et al., 1989, Nucleic Acids Res. 17: 517-522). The identification of such elements would be extremely useful in the construction of recombinant APP minigenes. These minigenes can then be introduced into the germline of transgenic mice, thus providing animal models for AD.

SUMMARY OF THE INVENTION

The present invention provides recombinant minigenes for the expression of alternative forms of APP, including APP-695, APP-751, APP-770, and a variety of mutant forms of APP. The present invention also provides for the introduction of such functional APP minigene constructs into the germline of mice thereby generating transgenic animal models of AD useful in the identification of the molecular mechanisms of AD pathogenesis. The recombinant minigenes according to the present invention contain essentially five different elements: (1) gene promoter (DNA elements responsible for gene regulation), (2) and (3) APP protein coding region (cDNA or mutated cDNA), (4) mRNA polyadenylation signals, (5) RNA splicing signals and genomic elements required for developmentally appropriate and cell/tissue-specific expression of the APP-encoding DNA. The identification of such genomic elements is highly unpredictable. The location of these sequence elements varies from gene to gene and may be found in the 5' regions, within introns, in 3' regions, or in other locations.

It has now been unexpectedly found that an -4.6 kb EcoRI human genomic fragment (or portions thereof), comprising -2.8 kb 5' to the APP in RNA start site, the first exon of the APP gene and -1.6 kb of the first intron, is sufficient to direct cell and tissue-specific expression of a reporter gene in transgenic mice, and in a manner consistent with the expression pattern of the endogenous mouse APP gene. This genomic fragment contains a promoter and perhaps other regulatory elements that facilitate the expression of recombinant APP minigenes with a cell and tissue specificity consistent with the formation of amyloid plaque and the expression patterns of the APP gene. Since the primary defect leading to AD has not yet been determined, and specific mutations which cause AD in humans have not been identified, transgenic mice with recombinant APP minigenes according to the present invention provide animal models for the disease. For example, the generation of transgenic animal models for A4 amyloidosis is essential for defining the role of A4 in the pathogenesis of AD. Transgenic mice, according to the present invention, carrying APP genes altered in their protein-coding sequences or in their expression levels, provide models

for exhibition of dominant mutant phenotypes resembling some aspects of AD pathology. As Alzheimer's pathology is restricted to specific regions of the brain, only those minigene constructs with the appropriate cell and tissue-specific genomic regulatory elements, such as those provided by the present invention, will enable for the development of transgenic mouse models of AD.

5

BRIEF DESCRIPTION OF THE DRAWINGS

Figure 1 is the cDNA sequence (SEQ ID NO:42) of the amyloid precursor protein (APP) (SEQ ID NO:43) cloned in pFC4.

10 Figure 2 is a circular map of pFC4.

Figure 3 is an illustration of the 5'-end of the APP gene.

Figure 4a is an illustration of gene products of nonmutated forms of APP encoded in APP minigenes.

Figure 4b is an illustration of gene products of mutated forms of APP encoded in APP minigenes.

15 Figure 5 is an illustration of the construction intermediates and products: pMTI-2302, pMTI-2303, pMTI-2305 and pMTI-2304.

Figure 6a is an illustration of polylinkers in cloning vectors: pWB16, pMTI-2110, pMTI-2300 and pMTI-2301.

Figure 6b is a circular map of pMTI-2301.

20 Figure 7a is an illustration of construction intermediates pMTI-2306, pMTI-2307, pMTI-2311 and pMTI-2312 and minigene pMTI-2314.

Figure 7b is a circular map of pMTI-2307.

Figure 7c is a circular map of pMTI-2312.

Figure 8a is an illustration of minigene constructs pMTI-2310, pMTI-2314, pMTI-2319, pMTI-21320, pMTI-2321, pMTI-2322, and pMTI-2325, encoding alternate forms of APP.

25 Figure 8b is a circular map of pMTI-2314.

Figure 9 is an illustration of construction intermediates pMTI-2307, pMTI-2316, and pMTI-2317 and minigene pMTI-2318.

Figure 10a is an illustration of construction intermediates pMTI-2312 and mouse metallothionein-I genomic sequences and minigenes pMTI-2323, pMTI-2331, pMTI-2332, pMTI-2324, and pMTI-2326.

30 Figure 10b is a circular map of pMTI-2323.

Figure 11a is an illustration of construction intermediate pMTI-2323 and minigenes pMTI-2327 and pMTI-2337.

Figure 11b is a circular map of pMTI-2337.

35 Figure 12 shows the DNA (SEQ ID NO:44)/amino acid (SEQ ID NO:45) sequence of sp-spacer A4 and MC-100.

Figure 13 shows the DNA (SEQ ID NO:46)/amino acid (SEQ ID NO:47) sequence of sp-spacer A4 and SP-A4.

Figure 14 is an illustration of construction intermediate pMTI-2328, a pFC4 fragment, and minigenes pMTI-2329, pMTI-2333, pMTI-2334, pMTI-2335 and pMTI-2336.

40 Figure 15a is an illustration of APP 3'-end genomic clone pSV1 and minigene pMTI-2339.

Figure 15b is a circular map of pMTI-2339.

Figure 16 is the DNA (SEQ ID NO:48) sequence of the 3'-end of the APP gene.

Figure 17 is a circular map of pNotSV2neo.

45 Figure 18a is an illustration of pNotSV2neo subclones for minigenes pMTI-2360, pMTI-2361, pMTI-2362, pMTI-2363, pMTI-2364, pMTI-2365, pMTI-2366, pMTI-2367, pMTI-2368, and pMTI-2369.

Figure 18b is a circular map of pMTI-2360.

Figure 19 is an illustration of pNotSV2neo and minigenes pMTI-2339, pMTI-2369, pMTI-2342, pMTI-2343 and pMTI-2344.

Figure 20 is an illustration of the APP-lacZ reporter gene pMTI-2402.

50 Figure 21(a-d) illustrates the cellular distribution of APP mRNA in normal mouse detected by in situ hybridization with labeled single-stranded human APP DNA probe. (a) Section of mouse cerebral cortex. (b) Section of mouse cerebellar cortex. (c) Section of mouse trigeminal ganglia. (d) Section of mouse liver.

Figure 22 illustrates the histochemical staining pattern of *E. coli* β -galactosidase activity in brain section of a BE803 transgenic mouse.

55 Figures 23(a-d) illustrates the histochemical staining pattern of *E. coli* β -galactosidase activity in serial brain sections of a BE803 transgenic mouse (a, b and c) and in a section of a normal mouse brain (d).

Figure 24(a-d) illustrates the histochemical staining pattern of *E. coli* β -galactosidase activity in sections of cerebellar cortex (a and b), trigeminal ganglion (c), and liver (d) from transgenic BE803 mouse.

Figures 25(a-d) illustrates the cellular and subcellular distribution of *E. coli* β -galactosidase in transgenic BE803 mouse brain. Light microscopic image of histochemical staining pattern of *E. coli* β -galactosidase activity in cerebral cortex (a). Normarski optic image of histochemical staining pattern of *E. coli* β -galactosidase activity in cerebral cortex (b and c). Immunogold localization of *E. coli* β -galactosidase in cerebral cortex section from a BE803 transgenic mouse.

Figure 26 shows an S1 analysis of human APP RNA expression in the brain of a series of transgenic mice.

Figure 27 shows an S1 analysis of human APP RNA expression in the brain of a second series of transgenic mice.

Figure 28a is a Western-blot of APP-695, APP-751 and APP-770 protein expression in the brain of a normal mouse and transgenic mice carrying human APP minigenes using monoclonal antibody (mAb) 22C-11.

Figure 28b is a Western-blot of human APP-751 protein expression in the brain of a normal mouse and transgenic mice carrying human APP minigenes using mAb 56-1.

Figure 29 is a Western-blot (using mAb 22C-11) of APP-695, APP-751 and APP-770 protein expression in COS cells transfected with human APP minigenes.

Figure 30a illustrates circular maps of pMTI-4 and pMTI-38.

Figure 30b illustrates circular maps of KS Bluescript, pMTI-41, pMTI-43 & 44 and pMTI-42.

Figure 31 is an illustration of construction intermediates and products pMTI-52 to pMTI-53, pMTI-57 and pMTI-58.

Figure 32 illustrates reactivities of Kunitz monoclonal antibodies (56-1, 56-2, 56-3) with APP proteins.

Figure 33 illustrates the primate specificity of monoclonal antibody 56-1.

Figure 34 shows the immunocytochemical staining of a brain tissue section from transgenic mouse AE301 + 207(F1) using rabbit polyclonal antibody pAb 90-29.

Figure 35 shows the immunocytochemical staining of a brain tissue section from transgenic mouse AE301 + 207(F1) using rabbit polyclonal antibody pAb 90-29 (higher magnification of similar field described in Figure 34).

Figure 36 shows the immunocytochemical staining of a brain tissue section from transgenic mouse AE301 + 207(F1) using rabbit polyclonal antibody pAb 90-28 (magnification similar to that described in Figure 35).

Figure 37 shows the immunocytochemical staining of a brain tissue section from transgenic mouse FE803 + 105(F1) using rabbit polyclonal antibody pAb 90-29 (magnification similar to that described in Figure 35).

Figure 38a is an electron micrograph of a thin section of brain tissue from the hippocampal region of transgenic mouse AE301 + 201(F2).

Figure 38b is an electron micrograph of a thin section of brain tissue from the hippocampal region of transgenic mouse AE301 + 201(F2) (different field than described in Figure 38a).

Figure 39 is an electron micrograph of immunogold staining of ultrathin cryosections of brain tissue from the hippocampal region of transgenic mouse AE301 + 201(F2) using rabbit polyclonal antibody (pAb) 90-29.

Figure 40 is a circular map of pMTI-70.

Figure 41 is a circular map of pMTI-2371.

Figure 42 is a Western-blot, using pAb SG369, of MC-100 protein expression in pMTI-70 transfected cell lines cMTI70-B1, cMTI70-B2, and cMTI70-B3, and cell lines cMTI52-A4, cMTI66-B6, cMTI66-C5, cMTI69-C6, cMTI69-A4, and cMTI69-A5 which are included as negative controls.

Figure 43 is a Western-blot, using pAb SG369, of MC-100 protein expression induced with cadmium in transfected cell lines cMTI70-A2, cMTI70-A3, cMTI70-A6, cMTI70-B1, cMTI70-B2, and cMTI70-B3 (transfected with pMTI-70). Cell lines cMTI63-B1, cMTI63-C2, and cMTI53-A1 are included as negative controls.

Figure 44a shows the immunofluorescence, using pAb SG369, of MC-100 protein expression in transfected cell line cMTI70-A6.

Figure 44b shows the immunofluorescence, using pAb SG369, of MC-100 protein expression in transfected cell line cMTI70-A6 (higher magnification, different field than described in Figure 44a).

Figure 44c shows the immunofluorescence, using pAb SG369, of control transfected cell line pMTI53-A1 (same magnification as described in Figure 44a).

Figure 45 is a Western-blot of immunoprecipitated (using pAb SG369) MC-100 protein from cadmium-induced, pMTI-70 transfected cell line cMTI70-A6.

Figure 46 demonstrates human APP RNA expression, using riboprobe analysis, in the brain of a series

of transgenic mice.

DESCRIPTION OF THE PREFERRED EMBODIMENT

6 AD (Alzheimer, 1907, supra) is characterized by a widespread functional disturbance of the human brain. Fibrillar amyloid proteins are deposited inside neurons as neurofibrillary tangles (Katzman, 1983, supra) and extracellularly both as amyloid plaque cores (Katzman, 1983, supra) and as cerebrovascular amyloid, (Katzman, 1983, supra). The major protein subunit (A4) of the amyloid fibril of plaques, blood vessel deposits, and potentially of tangles is an insoluble, highly aggregating 40-42 residue peptide of relative molecular mass 4,500 (Masters et al., 1985, supra and 1985, supra; and Glenner and Wong, 1984, supra). The A4 peptide which derives from a larger amyloid precursor protein is encoded by a gene on chromosome 21 (Kang et al., 1987, supra; Goldgaber et al., 1987, supra; Tanzi et al., 1987, supra). APP mRNAs are detected in neurons and in other tissues both within and outside the brain (Goedert, 1987, supra; Cohen et al., 1988, supra; Higgins et al., 1988, supra).

15 Age, genetic elements, and, potentially, environmental factors appear to contribute to cellular pathology in AD, but mechanisms that lead to these brain lesions are not yet understood. A fundamental question in the pathogenesis of AD is the relationship between the observed neuronal abnormalities and the deposition of amyloid.

20 Because the primary defect leading to AD is not yet known, and specific mutations which cause AD in humans have not been defined, animal models for the study of AD would be especially useful. With the exception of aged primates, no laboratory animal model for AD exists. Due to these limitations, the generation of transgenic mouse models for AD may be the best approach in defining the role APP plays in the etiology of AD. Transgenic mice carrying APP genes which have been altered either in their protein-coding sequences or in their expression levels may lead to dominant mutant phenotypes resembling those displayed by the AD pathology. The introduction of functional minigene constructs described herein into the germline of mice has been used to generate models of AD and to identify the molecular mechanisms of pathogenesis.

30 A critical step for the development of a transgenic mouse model for AD was the design of a minigene that allows high-level expression of a foreign gene in a predictable tissue-specific fashion. Recombinant minigenes according to the present invention contain essentially five different elements: gene promoter (DNA elements responsible for gene regulation), protein coding region (cDNA), mRNA polyadenylation signals, RNA splicing signals, and genomic elements required for correct developmental expression of DNA that has participated in a developmental program (the location of these sequence elements can vary from one gene to another and can be found within introns, 3' regions, and in other locations).

35 The following paragraphs and examples describe essential steps leading to the design and construction of such minigenes for the generation of animal models for AD. A gene promoter has been isolated and characterized which in transgenic animals confers an expression pattern of foreign genes that is comparable with the pattern of expression of the endogenous mouse APP gene. A series of minigenes comprising the APP gene promoter and a variety of different APP gene products including mutant forms have been generated. Transgenic animals, expressing these minigenes, are useful in the investigation of the *in vivo* function of various APP gene products, the regulation and expression patterns of the APP gene, and the relationships of these processes to the formation of amyloid. The use of various RNA splicing and polyadenylation signals in the minigenes allows for the optimization of post-transcription processing and stability of human APP transcripts in transgenic animals.

45 Appropriate recombinant minigenes were generated and tested. The minigenes were microinjected directly into the male pronucleus of mouse 1-cell embryos. The manipulated embryos were subsequently transferred to the oviducts of pseudopregnant females. Litters from recipients were screened for the presence of the transferred minigene (transgene) in their genome by polymerase chain reaction (PCR) analysis and Southern-blot analysis of DNA derived from tail biopsies.

50 Because Alzheimer's pathology is restricted to specific regions of the brain (Price, 1986, supra), the choice of an appropriate gene promoter for minigene constructions was critical for the development of the transgenic mouse model. A regulatory element comprising a gene promoter and perhaps other regulatory sequences must be utilized which will facilitate the expression of recombinant genes with a cell and tissue specificity consistent with the formation of amyloid plaque and the expression patterns of the APP gene. The present invention provides such a regulatory element.

55 An ~4.5 kb genomic fragment described herein encompassing the 5'-end of the human APP gene (Figure 3) had sufficient sequence information to direct cell and tissue-specific expression of the protein product of a reporter gene, *E. coli lacZ*, in transgenic mice (Figures 20 to 25). The expression pattern of the

reporter gene product β -galactosidase in the central nervous system (CNS) was strikingly consistent with the expression pattern of the endogenous mouse APP gene and is consistent with the pattern of senile plaque deposition characteristic of AD patients. *In situ* hybridizations, using human APP cDNA as probe, revealed APP mRNA expression in specific brain regions, including: hippocampus, dentate gyrus, cerebral cortex, cerebellar cortex, pons, and spinal cord. β -galactosidase staining, in transgenic brain tissue, was restricted to areas containing neuronal perikarya. In most cases, the β -galactosidase staining in the CNS of BE803 transgenic mice was consistent with *in situ* hybridization patterns of mouse APP mRNA. One exception was the CA3 region of the hippocampus where the β -galactosidase staining was not as intense as would be expected from the observed levels of mouse APP mRNA. This difference may have been due to a lowered expression level of the reporter gene in this region or due to altered stability of the β -galactosidase fusion protein. The majority of β -galactosidase fusion protein was localized in secondary lysosomes within neuronal perikarya, therefore, *E. coli* β -galactosidase fusion protein may be relatively unstable in neurons.

A variety of cDNAs encoding various forms of APP and mutants of APP were constructed. Three alternate forms of APP exist, designated APP-695, APP-770 and APP-751, all of which are encoded by a single common gene on human chromosome 21. The mRNA of the APP gene is differentially spliced to yield three gene products of 695 amino acids (aa), 751 aa, and 770 aa in length. The 751 aa and 770 aa forms contain an additional domain which has striking homology to a Kunitz type serine protease inhibitor (Kitaguchi et al., 1988, *Nature* 331: 530-532; Ponte et al., 1988, *Nature* 331: 525-527; Tanzi et al., 1988, *Nature* 331: 528-530). Expression of one or more forms of the human APP gene products in transgenic mice provides a model with which to test the hypothesis that over-expression or anomalous expression of one or more forms of the gene results in Alzheimer's pathology. This hypothesis is not inconsistent with the observation that Alzheimer's pathology (i.e., A4 plaques in brain tissue) has been found in individuals with DS past the age of 30-40 (Glennner and Wong, 1984, *Biochem. Biophys. Res. Commun.* 122: 1131-1135). Such individuals are trisomic for chromosome 21 which contains the APP gene, and the levels of APP mRNA in these individuals appears to be elevated (Tanzi et al., 1988, *Science* 235: 880-885).

Human APP cDNA clones corresponding to the three alternative APP forms were isolated. Plasmid pFC4 contains the full-length cDNA (SEQ ID NO:42) for the 695 aa (SEQ ID NO:43) form of APP (Kang et al., *supra*). Using pFC4 as a probe, a human neuroblastoma cDNA library was screened for the presence of additional transcripts corresponding to additional forms of human APP. An ~1.8 kb cDNA was identified which contained both additional exons found in APP-770 (167 bp plus 58 bp), and represented a partial cDNA of the mRNA. Unique restriction sites (*AccI* and *BglII*) were used to subclone this 1775 bp fragment into the original pFC4 full-length clone, thus generating a full-length cDNA clone (pFC4-770) for the 770 aa form of APP. The 751 residue APP encoding cDNA clone (pFC4-751) was engineered by *in vitro* mutagenesis of pFC4-770. The deletion of 58 bp (M13-looping-out) was confirmed by DNA sequence analysis.

Using the various APP cDNAs, minigenes expressing each APP form were constructed: pMTI-2314 for APP-695 expression, pMTI-2319 for APP-770 expression and pMTI-2320 for APP-751 expression. As an initial step in the construction of an APP-695 minigene, the *EcoRI* promoter fragment of APP was inserted into the *HindIII* site of pMTI-2301 by blunt-end ligation to produce pMTI-2307. The construction of the APP-695 minigene was completed in a stepwise fashion. pMTI-2311 was generated by ligating the *BamHI* fragment from pFC4 into the *BamHI* site of pMTI-2307. Next, the *XhoI* fragment from pFC4 was inserted into the *XhoI* site of pMTI-2311 to generate pMTI-2312. Finally, a *SphI* fragment of pMTI-2304 containing the SV40 RNA splicing and polyadenylation signals was inserted at the *SphI* site of pMTI-2312 to yield pMTI-2314. The APP-751 and APP-770 minigenes were constructed by subcloning the *AccI*-*BglII* fragments from pFC4-751 and pFC4-770 into the *AccI*-*BglII* sites of pMTI-2314 to generate pMTI-2320 and pMTI-2319, respectively.

A second minigene series for expression of APP-695, APP-770 and APP-751 can be constructed using a truncated APP promoter. For minigene, pMTI-2310 (APP-695), the ~2.6 kb *HindIII* fragment of the 5'-end of the APP gene [Figure 3] was inserted into the *HindIII* site of the pMTI-2301 to generate pMTI-2306 (Figure 7a). The minigene expressing the 695 form of APP, pMTI-2310, was constructed in the same manner as pMTI-2314 described above (Figure 7a). The corresponding 751 and 770 minigenes can be generated as described above using the ~1.8 kb *AccI*-*BglII* restriction fragment.

The accumulation of A4 peptide in amyloid plaques may be the result of anomalous proteolytic degradation of one or more APP forms (695, 751, 770). Minigenes have been constructed which can directly express either the A4 peptide or other fragments of APP that may exist as proteolytic intermediates during *in vivo* generation of A4. Such APP fragments may, if they contain the A4 region, self-aggregate, and be further processed by the cell to alternately generate A4. The types of minigene which were constructed and which express such mutants are summarized in Figure 4b. Gene product IV is devoid of a portion of

the transmembrane domain and the entire cytoplasmic domain, leaving the A4 domain intact. This mutant gene product is expected to be secreted from the cell and perhaps further degraded to produce the A4 peptide. The secreted protein may also have other biological effects because at least some portion of APP has been shown to be shed from cell surfaces. Gene product V (designated as MC-100) is translated into the membrane and, therefore, a precursor protein was constructed which contains the 17-residue signal peptide of APP at the N-terminus. If the signal peptide is omitted, the C-100 protein (gene product VI) would be translated into the cytoplasm and perhaps have significantly different properties than if inserted into a membrane. Gene product VIII in which the signal peptide is also omitted should produce intracellular A4 directly, and which will not be inserted into a membrane. Another construct also expressing the A4 peptide including the APP signal peptide (gene product VII) was prepared. After the signal peptide cleavage point, gene product VII includes 40 amino acids encompassing the A4 peptide as well as 12 additional amino acids N-terminal of the A4 peptide region. This protein is expected to translocate through the cellular membrane and aggregate following proteolytic cleavage by the cell to generate A4.

To construct mutant APP minigenes for expression of truncated APP product, gene product IV and VII mutants, C-terminal frameshift mutations were generated. Frameshift mutations (-1, +2) of the cDNA sequences immediately following the A4 coding region brought a translation stop codon into the reading frame following the A4 peptide coding region. The resulting sequence encodes a truncated APP species (Figure 4b, gene product IV). A frameshift mutation (deleting nucleotide C) at the nucleotide position 2045 generated a stop codon after 40 amino acids from the N-terminus of the A4 sequence (amino acids 38, 39 and 40 are different than the native A4 sequence), and a +2 mutation (TG) after nucleotide position 2050 generated a stop codon after 41 amino acids from N-terminus of the A4 sequence (the last amino acid is different than the native A4 sequence). The +2 mutation was utilized in construct pMTI-2321 (Figure 8a). The generation of these frameshift mutations is described in co-assigned patent application U.S. Serial No. 194,053. A third frameshift mutation, "mutant 40-1," deleted an adenosine nucleotide at nucleotide 2055 (APP-695 cDNA sequence; Figure 15) and brought a translation stop codon into the reading frame directly following the 40th codon of the A4 peptide coding region (used in plasmids pMTI-2322, pMTI-2326, pMTI-2341, pMTI-2343, pMTI-2361). The frameshift mutations were inserted into pMTI-2314 (APP-695), pMTI-2319 (APP-770), or pMTI-2320 (APP-751) by swapping sequence domains between the unique BglIII and Clal restriction sites (Figure 8a). The deletion mutation was also generated by site-directed mutagenesis which placed the stop codon directly past the A4 sequences (pMTI-26). The mutation in pMTI-26 was inserted into the minigenes in a similar manner as described above.

To construct mutant APP minigenes for expression of gene product VIII mutant, the following steps were taken. Minigene pMTI-2318 (gene product VIII; Figure 4b) was generated in stepwise fashion (Figure 9). A BglIII-BamHI fragment from pMTI-26 containing the 42 aa A4 peptide sequence was inserted into the BamHI site of pMTI-2307. Next, the BamHI to BamHI fragment of pFC4 was inserted into the BamHI site of pMTI-2316. Finally, the SphI fragment containing the SV40 RNA processing signal was inserted into the SphI site of pMTI-2317.

Because of substantial sequence homology between mouse and human APP gene products, it has been difficult to generate adequate antibodies that will allow unequivocal identification of APP using immunohistochemical analysis of tissue sections. To circumvent this problem, a highly antigenic epitope of Chlamydia was inserted into the APP-695 sequences at either the site of the Kunitz inhibitor domain insertion or the extreme C-terminus of the protein. The sequences were transferred into the minigenes using either the AccI and BglIII restriction sites to generate pMTI-2325 (Figure 8a) or pMTI-2324 (Figure 10a).

In another series of minigene constructs, alternate RNA processing signals were used. Because minigenes utilizing RNA processing signals derived from the human APP gene or from an exogenous mouse gene might be expressed more efficiently in transgenic mice than those derived from SV40, constructs were generated which utilize RNA splicing and polyadenylation sequences of the mouse metallothionein gene. Alternatively, a genomic fragment from the 3'-end of the human APP gene which encompassed the APP polyadenylation signals was utilized. Minigenes expressing all of the gene products described above and additional forms were generated using the alternate RNA processing signals as follows.

Using the metallothionein gene body (Figure 10a) as a source of RNA processing signals, minigenes expressing the three alternate forms of APP (695, 770, 751) and mutant APP forms described above were constructed. To generate minigene pMTI-2323 for expression APP-695, the -2.2 kb BglIII to EcoRI fragment from the EcoRI genomic clone of the mouse metallothionein-I gene, pJYMMT(L), was inserted into the Clal site of pMTI-2312 by blunt-end ligation to generate pMTI-2323. Minigenes expressing alternate APP forms, APP-770 and APP-751, were generated by switching sequence domains (AccI to BglIII fragment) from

minigenes (expressing APP-751 or APP-770) utilizing the SV40 polyadenylation sequence (Figure 8a) to pMTI-2323 (Figure 10) to generate pMTI-2331 and pMTI-2332. To generate a minigene pMTI-2326 expressing an APP C-terminal frameshift mutant, the BglIII to ClI site fragment from pMTI-2322 (Figure 8a), containing mutation 40-1, was switched with sequences between BglIII to ClI site of pMTI-2312 (Figure 7a) to generate pMTI-2326a. Then, the ~2.2 kb metallothionein fragment (BglIII to EcoRI fragment, see Figure 10a) was inserted into the ClI site of pMTI-2326a to generate pMTI-2326. Alternatively, the BglIII to SpeI fragment of pMTI-2322 was swapped directly into pMTI-2323 to produce pMTI-2326 (Figure 10a).

To generate minigene pMTI-2327 coding for C-100 (gene product VI, Figure 4b), the sequences between the NruI and BglIII restriction sites of pMTI-2323 were deleted (Figure 11a). A translation initiation codon, ATG, directly precedes the first codon of the A4 sequences. To generate minigene pMTI-2337 coding for MC-100, the sequences between the KpnI and BglIII sites of pMTI-2323 (Figure 11a) were deleted and the clone was ligated using synthetic oligonucleotide adaptor, sp-spacer-A4 (SEQ ID NO:44) (Figure 12). MC-100 (gene product V, Figure 4b) required the 17 residue signal peptide of APP to direct insertion of the translated mutant protein into the membrane. The signal peptide should be cleaved and eliminated during the process. The nucleotide (SEQ ID NO:44) and amino acid (SEQ ID NO:45) sequence of MC-100 is presented in Figure 12.

To generate minigene pMTI-2341, a process analogous to that used to generate pMTI-2337 (Figure 11a) was used. This involved deleting the sequences between the KpnI and BglIII sites of pMTI-2326 (Figure 10a) and ligating the clone using synthetic oligonucleotide adaptor sp-spacer-A4 (SEQ ID NO:46) (Figure 13). Minigene pMTI-2341 (gene product VII or sp-A4; Figure 4b) thereby generated should express an A4 peptide linked to the APP signal peptide. The nucleotide (SEQ ID NO:46) and amino acid (SEQ ID NO:47) sequence of sp-A4 is shown in Figure 13.

For the alternate series of the minigenes incorporating the human APP gene-derived RNA processing signals, the 3'-end of the APP gene was isolated in clone pVS-1. Clone pVS-1 contained an ~1.5 kb EcoRI fragment of human genomic DNA which encompasses the 3'-end of the terminal exon of human APP and the APP polyadenylation signal inserted into the EcoRI site of pUC19, Figure 15a. The ~1.5 kb APP genomic fragment was isolated from a charon 21A lambda library of human chromosome 21 DNA (A.T.C.C. No. LA21NS01). The SmaI-SphI (nucleotides 3102 to 3269) fragment from the APP cDNA clone, pFC4, was labeled as probe and used to screen the lambda library for the APP 3'-end genomic. The nucleotide sequence of the ~1.5 kb APP genomic fragment is shown in (SEQ ID NO:48) and Figure 16.

The minigene construct, pMTI-2339, designed to express APP-695 was generated by inserting the ~1.3 kb SphI fragment from pVS-1 into the SphI site of pMTI-2312 (Figure 7a) yielding pMTI-2339 (Figure 15a). Minigenes expressing APP-751 and APP-770 and the mutants indicated below were generated by switching sequence domains of pNotSV2neo subclones of the APP constructs (Figure 18a). The subclones were utilized for switching sequence domains because of the presence of convenient restriction enzyme sites. NotI fragments of many APP minigenes were subcloned into pNotSV2neo (see Figure 18a) so that APP expression could be determined in transient transfections of COS cells. The construct encoding APP-770 (pMTI-2342, Figure 19) was generated by swapping the PvuI to SpeI fragment from pMTI-2363 (Figure 18a) to pMTI-2369 (Figure 19). A construct which encodes APP-751, pMTI-2345, was generated in an analogous fashion.

To generate minigene pMTI-2343 expressing mutant 40-1, the sequence domain encompassing the frameshift mutant, 40-1, was inserted into pMTI-2369 by swapping sequences between the PvuI and SpeI restriction sites from pMTI-2361 (Figure 18a) to pMTI-2369 (Figure 19).

To generate minigene pMTI-2340 encoding mutant, MC-100, the sequences between the KpnI and BglIII sites of pMTI-2339 (Figure 15a) were deleted and the clone ligated using synthetic oligonucleotide linkers (sp-spacer-A4, Figure 12).

To generate minigene pMTI-2344 encoding mutant sp-A4, the sp-A4 mutant was inserted into pMTI-2369 by swapping sequences between the PvuI and SpeI restriction sites from pMTI-2365 (Figure 18a) to pMTI-2369 (Figure 19).

A number of the APP minigenes prepared as described in the Examples which follow were used to prepare transgenic mice expressing an APP transgene. Such transgenic mice are useful as models for the study of AD.

EXAMPLE 1

Elements of APP Minigenes:
Gene Promoter and Regulator Elements for Cell- and Tissue-Specific Expression

A critical step in the development of a transgenic mouse model for the pathology of AD is the isolation of an appropriate gene promoter for minigenes to be used as transgenes. A gene promoter and perhaps other regulatory elements must be identified that facilitate expression of recombinant APP minigenes with a cell and tissue specificity consistent with the formation of amyloid plaque. As a first step, fragments containing various portions of the 5'-end of the human APP gene from human genomic libraries were isolated. The 5'-end of the APP gene has been shown to contain DNA sequence elements which function as gene promoters in cell culture (Salbaum et al., *supra*). The starting material for the isolation of an ~2.5 kb HindIII fragment was a human genomic library available from the A.T.C.C. under accession number LL21NS02. This library was prepared by using a fluorescence-activated cell sorter to obtain a fraction enriched for human chromosome 21. This fraction was digested with HindIII and cloned into the lambda vector Charon 21A. This HindIII human chromosome 21 library was plated on 6 plates at an approximate density of 5×10^4 pfu/plate. Screening of duplicate filters of the library representative of 3×10^5 total pfu was done by conventional methods (Benton and Davis, 1977, *Science* 196: 180) using an ~1.0 kb cDNA probe derived from plasmid pFC4. Plasmid pFC4 (Figure 2) is described in Example 3. It contains an ~3.3 kb cDNA insert having the sequence shown in (SEQ ID NO:42) and Figure 1. The ~1.0 kb probe was obtained from the Apal site at nucleotide position 52 to the XhoI site at nucleotide position 1056. A 91 bp probe was also used to confirm the initial screen with the ~1.0 kb probe. This small confirming probe was derived from pFC4 as an Apal (nucleotide 52) to NruI (nucleotide 144) fragment. Clones which hybridized were plaque-purified through three subsequent cycles of screening and purification until a 100% positive hybridization response was obtained. One such plaque-purified clone was designated ϕ MTI 3509 (λ 12A). ϕ MTI 3509 contained a genomic insert of ~2495 bp. This HindIII insert was subcloned into the HindIII site of plasmid pUC18 (Yanisch-Peron et al., 1985, *Gene* 33: 103) and designated pMTI-3501 (pUC18/pAL12A-12). Plasmid pMTI-3501 was found to contain ~487 bp of sequence 5' to the first nucleotide of the cDNA insert of plasmid pFC4 (shown in SEQ ID NO:42 and Figure 1).

Using an ~181 bp genomic probe derived from pMTI-3501 (from the Apal site at -128 to Apal at 52), an EcoRI human genomic chromosome 21 cell sorter-enriched library available from the A.T.C.C. under accession number LA21NS01 was screened in a manner similar to that described above for the HindIII library. One plaque-purified clone, designated ϕ MTI 3522 (λ pE-1) contained an insert of ~4638 bp. This ~4.6 kb insert was subcloned into the EcoRI site of plasmid pUC19 (Yanisch-Peron et al., *supra*) and designated pMTI-3515 (pUC19/pE-12). Plasmid pMTI-3515 was found to contain ~2831 bp 5' to the first nucleotide of the cDNA insert of plasmid pFC4 (Figure 1).

The genomic inserts of both pMTI-3501 and pMTI-3515 containing sequences 5' to the cDNA sequence of pFC4 interrupt the KpnI site of the cDNA insert of the pFC4 at position 207. This KpnI site was not present in the genomic DNA at the junction of the boundary between exon 1 and intron 1, but was created at the splice site of the mRNA. Plasmid pMTI-3501 and plasmid pMTI-3515 encode ~1.6 kb and ~1.4 kb of intron 1, respectively. Plasmid pMTI-3515 was shown to contain ~2.8 kb of sequences 5' to the APP start site of transcription, along with exon 1 (encoding amino acids 1-19 of APP) and part of the first intron (~1.8 kb) as shown in Figure 3.

40 EXAMPLE 2

Elements of APP Minigenes: SV40-derived Polyadenylation and RNA Splicing Signals

SV40 virion DNA (Hay and DePamphilis, 1982, *Cell* 28: 767-779; also commercially available from International Biotechnologies, Inc. (IBI) as catalog no. 33200) was digested with BamHI and BclI. The small ~0.2 kb BamHI-BclI fragment (2533 bp to 2770 bp) containing two RNA polyadenylation signals (one in each strand) (see, DePamphilis and Bradley, 1986, in *The Papovaviridae*, Volume 1, Salzman (ed.), Plenum Publishing Corp., NY) was "shotgun" cloned into plasmid pUC19 as follows. The BamHI- and BclI-digested SV40 DNA was mixed with BamHI-digested pUC19 DNA. The restriction enzymes were removed via phenol-chloroform extractions and the DNA was ligated overnight at 12°C using T4 ligase (commercially available from New England Biolabs (NEB) as catalog no. 202). Impurities, including any residual phenol or chloroform were removed from the ligated DNA by GENECLEAN (available from BIO 101 Inc., P.O. Box 2284, La Jolla, CA. 92038). This DNA was used to transform competent DH5 α E. coli cells (commercially available from Bethesda Research Laboratories (BRL), Gaithersburg, MD 20877). The transformants were screened by miniprep analysis using BamHI digestion and HpaI/HindIII digestions to determine the orientation of the inserted DNA. The desired ~2.9 kb plasmid was designated pMTI-2302 (Figure 5).

SV40-derived RNA splicing signals from plasmid pFC4 were inserted into pMTI-2302 as follows. First,

the NruI restriction endonuclease site at nucleotide position 144 of the APP cDNA sequence (shown in Figure 1) was converted to a BglII restriction endonuclease site using blunt-end linkers to yield plasmid pMTI-2303 (Figure 5). For this conversion, pFC4 was digested with NruI and the linear ~6.4 kb DNA fragment was purified with GENECLAN and then ligated with 0.5 OD₂₆₀ units of BglII linkers (NEB catalog no. 1036) using T4 ligase [incubation for 5 hours at 16° C]. Linkers were removed by gel-filtration using "Quick Spin Columns" (Boehringer Mannheim, catalog no. 100408). The linear DNA was recovered using GENECLAN and was circularized using T4 ligase to generate pMTI-2303 [diagnostic minipreps with BglII and XhoI digestion revealed fragments of ~0.35 kb, ~1.4 kb, and ~2.95 kb]. This procedure deleted APP encoding sequences from nucleotide position 145 to the BglII site downstream at nucleotide position 1915.

An ~0.35 kb fragment containing the SV40 splicing signals could be excised from plasmid pMTI-2303 DNA by digestion with XhoI and BglII. This XhoI-BglII fragment was gel-purified on a 5% polyacrylamide gel, eluted from the gel, then used for ligation with Sall-BamHI digested pMTI-2303 DNA to generate plasmid pMTI-2305 (Figure 5). In the next step, an SphI site was inserted into the EcoRI site of pMTI-2305 to generate plasmid pMTI-2304 (Figure 5). Plasmid pMTI-2305 was digested with EcoRI to yield an ~3.2 kb fragment and then dephosphorylated using CIAP (calf intestine alkaline phosphatase, reaction conditions suggested by manufacturer, Boehringer Mannheim, catalog no. 1097075). The DNA was extracted with phenol/chloroform/isoamylalcohol (24/24/1) and precipitated in 2.5 M ammonium acetate and 70% ethanol. The DNA fragment was ligated, using T4 ligase, to an EcoRI-SphI adaptor. The adaptor is a self-annealing oligonucleotide (Sequence 5'-AATTC³CGCATGCGGG-3' (SEQ ID NO:49); synthesized using an Applied Biosystems instrument and manufacturer's recommended methods, model no. 380A DNA Synthesizer) and was annealed by heating in solution (1 mM EDTA, 10 mM Tris pH 7.6) to 65° C and allowing sample to slowly cool to room temperature. Diagnostic minipreps of pMTI-2304 with SphI revealed fragments of ~0.6 and ~2.6.

An ~0.6 kb SphI cassette containing SV40-derived splicing signals and polyadenylation signals could be excised from pMTI-2304 DNA by digestion with SphI. This cassette was useful in the construction of APP minigenes described in the Examples below.

EXAMPLE 3

30 Elements of APP Minigenes: APP-695, -770, -751 Protein Coding Regions

Plasmid pFC4 is a cDNA clone similar to clone 9-110 described by Kang et al., 1987, Nature 325: 733-736 and contains a full-length cDNA encoding APP-695 (Figure 2). The cDNA library described by Kang et al., supra, was constructed by the method of Okayama and Berg, 1983, Mol. Cell. Biol. 3: 280-289, using polyA⁺ RNA isolated from brain cortex of a 5-month-old aborted human fetus. This cDNA library (~10⁵ E. coli HB101 transformants) was originally screened using a mixture of 64 20-mers as probes. The 20-mers had the sequence (SEQ ID NO:1):

40
5' -T T T T G A T G A T G C A C T T C A T A -3'
 C G G C G G

This sequence was deduced from the amino acid sequences of residues 10-16 of the A4 peptide. Nine positive clones were obtained, and one (clone 9-110) was selected for sequence analysis. The complete sequence of the clone 9-110 insert encoding a full-length APP-695 sequence is shown in Figure 1 of Kang et al., supra. This cDNA library was replated and screened with two different synthetic oligonucleotide probe mixtures of 17 and 20 nucleotides. The 17-mers had the sequence (SEQ ID NO:2):

50
5' -A C G T C T T C N G C G A A G A A -3'
 A C A A

where N is A, G, C or T. The 20-mers had the sequence (SEQ ID NO:3):

65
5' -T T T T G G T G G T G N A C T T C G T A -3'
 C A A C A

where N is A, G, C or T. Two positive clones, designated pFC4 and pFC7, were obtained which contained identical inserts as determined by restriction endonuclease mapping and partial DNA sequence analysis. Clone pFC4 was selected for further analysis and contained an ~3.4 kb insert encoding the full-length APP-695 sequence shown in Figure 1. The nucleotide sequence is identical to the sequence of 9-110 shown as
 5 Figure 1 Kang et al., *supra*.

A human neuroblastoma cDNA library was purchased from Clontech, Palo Alto, CA, catalog no. HL1007a, and screened for the presence of APP transcripts of the 751 aa and 770 aa forms of human APP. This λ library was probed with an ~1.4 kb BamHI fragment (nucleotide 99-1475) of pFC4. Two positive clones (λ E₁-b₁-1 and λ E₁-b₁-3) with identical inserts were obtained. These two clones each contained an
 10 ~2.0 kb cDNA insert comprising both of the additional exons (167 bp and 58 bp) found in APP-770 but represented only a partial cDNA of the full-length mRNA for APP-770. The ~2.0 kb insert was subcloned into the EcoRI site of plasmid pUC19 to generate plasmid pMTI-3525. A full-length cDNA for APP-770 was obtained by replacing the ~1.7 kb KpnI-BglIII fragment of pFC4 (nucleotide 207 - nucleotide 1915 of pFC4 sequence shown in Figure 1) with the ~.96 kb KpnI-BglIII fragment of pMTI-3525, generating plasmid pMTI-
 15 3521 (pFC4-770). Specifically, pMTI-3525 was digested with KpnI and BglIII, and the ~.96 kb KpnI-BglIII fragment was gel-purified. Plasmid pFC4 was similarly digested with KpnI and BglIII, and the ~4.7 kb KpnI-BglIII fragment was gel-purified. The two gel-purified fragments were mixed, ligated and used to transform *E. coli* DH5 α cells. The resulting ~6.6 kb plasmid pMTI-3521 was the source of the APP gene fragment for the construction of minigenes for the expression of the APP-770.

In order to obtain a full-length cDNA encoding the 751 aa form of APP, *in vitro* mutagenesis of plasmid pMTI-3521 was performed to delete the 58 bp sequence encoding the C-terminal 19 amino acids of the 75 aa protease inhibitor domain of APP-770. This was achieved by the M13-looping out procedure as described by Geisselsoder et al., 1987, *Biotechniques* 5: 786-791. DNA sequence analysis confirmed the successful deletion of the 58 bp segment of pMTI-3521 to generate plasmid pMTI-3524. Plasmid pMTI-
 20 3524 was the source of the APP gene fragment for the construction of minigenes for the expression of APP-751.

Plasmid pMTI-3524 was prepared according to the following series of steps. First, plasmid pMTI-3522 was constructed as follows. Plasmid pMTI-4 was partially digested with *AccI*, then filled-in with the Klenow fragment of DNA polymerase (Klenow) to remove one of the two *AccI* sites, ligated and used to transform *E. coli* DH5 α cells to yield plasmid pMTI-3526. Plasmid pMTI-3526 was digested with *AccI* and *BglIII*; the ~3.8 kb large fragment was gel-purified and ligated with the ~1.7 kb *AccI*-*BglIII* gel-purified fragment from pMTI-3525, then used to transform *E. coli* DH5 α cells. The desired transformant plasmid was designated pMTI-3522. Plasmid pMTI-3522 was then used to transform competent *E. coli* CJ236 cells which are uracil N-glycosylase-deficient. Several transformants were propagated and single-stranded uracil-containing pMTI-3522 (phage) DNA was generated with the use of R408 helper phage (available from Stratagene as catalog no. 200252). MUTA-1, a synthetic 60-mer which spans the junction of APP-751 and APP-695 was used to "loop out" the 57 nucleotides of pMTI-3522 to generate pMTI-3523. MUTA-1 has the sequence (SEQ ID NO:4):
 30

40 5' agtactgcatggccgtgtgtggcagcgcattcctacaacagcagccagtagccctgatg 3'

and was 5' phosphorylated and annealed to the single-stranded pMTI-3522 DNA in the presence of Gene 32 protein which assists the enzyme T4 DNA polymerase in copying the complementary strand. This mixture was used to transform competent *E. coli* XL-1 Blue Cells (available from Stratagene as catalog no. 200268) which are uracil N-glycosylase positive. Colorless plaques were picked for miniprep and sequence analysis. This procedure (Geisselsoder et al., 1987, *Biotechniques* 5: 786-791) greatly reduced the propagation of parental phage, thus enriching for the mutant strand. One of these positive clones was designated pMTI-3523.
 45

50 EXAMPLE 4

Construction of Minigenes pMTI-2314 and pMTI-2310 for Expression of APP-695

55 A. Minigene pMTI-2314

For the first step of the construction of minigene pMTI-2314 for the expression of APP-695, an ~4.6 kb *EcoRI* fragment derived from plasmid pMTI-3515 (Example 1; Figure 3) was inserted into the *HindIII* site of

plasmid pMTI-2301 (Figures 6a and 6b) by blunt-end ligation to yield plasmid pMTI-2307 (Figures 7a and 7b). Plasmid pMTI-2301 contains a unique HindIII cloning site, flanked by NotI restriction endonuclease sites, and was prepared by first replacing the EcoRI-HindIII polylinker of pUC19 (obtained from Bethesda Research Laboratories, Life Technologies, Inc., Gaithersburg, MD, catalog no. 95357) with the polylinker of pWE16 (available from Stratagene as catalog no. 251202), and then converting the HindIII site to an EcoRI site using adaptors. For the first step in the construction of pMTI-2301, two oligonucleotides purchased from NEB (catalog nos. 1107 and 1105) were annealed to yield the following double-stranded adaptor:

10 5' -AATTCGAACCCCTTCG-3' (#1105) (SEQ ID NO:5)
 3' -GCTTGGGAAGCTCGA-5' (#1107) (SEQ ID NO:6)

Then, plasmid pUC19 DNA was digested with EcoRI and HindIII and the ~2.7 kb fragment was gel-purified (using low melt agarose), ligated with the adaptor, and used to transform *E. coli* DH5 α cells. The desired transformant was designated pMTI-2110 (Figure 6a). For the second step in the construction of pMTI-2301, plasmid pMTI-2110 DNA was digested with EcoRI, then treated with calf Intestine alkaline phosphatase (CIAP), then gel-purified. CIAP was obtained from Boehringer Mannheim Biochemicals, Biochemicals Division, P.O. Box 50816, Indianapolis, IN 46250 (catalog no. 713 023). Plasmid pWE16 DNA was also digested with EcoRI. The EcoRI-digested pWE16 and gel-purified EcoRI-digested pMTI-2110 DNAs were mixed, ligated, treated with GENE CLEAN and used to transform *E. coli* DH5 α cells. The desired transformant plasmid was designated pMTI-2300. Miniprep analysis showed that NotI linearizes the ~2.7 kb plasmid. For the third step in the construction of pMTI-2301, plasmid pMTI-2300 DNA was digested with BamHI and ligated to self-annealing synthetic oligonucleotide adaptor (sequence 5'-GATCGGGAAGCTTCCC-3' (SEQ ID NO: 7); synthesized using an Applied Biosystems instrument and manufacturers recommended methods, model no. 380A DNA Synthesizer) in order to convert the BamHI site to HindIII. The oligonucleotide was annealed to yield the following double-stranded adaptor:

30 5' -GATCGGGAAGCTTCCC-3' (SEQ ID NO:7)
 3' -CCCTTCCAAGGCTAG-5' (SEQ ID NO:8)

The ligated DNA was treated with GENE CLEAN and used to transform *E. coli* DH5 α cells. Miniprep analysis of transformant DNA was performed using BamHI (plasmid remains uncut) and HindIII (linearizes plasmid). The desired transformant was designated pMTI-2301.

35 Plasmid pMTI-2301 DNA, thus obtained, was digested with HindIII, gel-purified, then treated with Klenow and CIAP. Then, plasmid pMTI-3515 DNA was digested with EcoRI and an ~4.6 kb fragment was gel-purified, treated with Klenow, and blunt-end ligated with the pMTI-2301 DNA prepared as described above. The ligated DNA was treated with GENE CLEAN and used to transform *E. coli* DH5 α cells. Transformants were screened by miniprep analysis using EcoRI. The desired transformant plasmid was designated pMTI-2307 and contained EcoRI fragments of ~4.7 kb and ~2.6 kb by miniprep analysis.

40 For the second step of the construction of pMTI-2314, an ~1.4 kb BamHI fragment of pFC4 comprising nucleotides 100-1475 (Example 3, Figure 1) was ligated into the BamHI site at nucleotide position 99 of the APC cDNA sequence in plasmid pMTI-2307 to yield plasmid pMTI-2311 (Figure 7a). Diagnostic miniprep analysis of pMTI-2311 DNA digested with XhoI and NotI revealed fragments of ~3.9 kb, ~2.7 kb and ~2.2 kb.

45 For the third step of the construction of pMTI-2314, an ~2.4 kb XhoI fragment of pFC4 comprising nucleotides 1056-3353 and including 3' sequences, poly A track and SV40 sequences found in the Okayama and Berg vector (Okayama and Berg, 1983, *supra*) was ligated into the XhoI site at nucleotide position 1056 to yield plasmid pMTI-2312 (Figures 7a and 7c).

50 For the final step of the construction of pMTI-2314, an ~0.6 kb Sph I fragment of pMTI-2304 containing SV40-derived RNA splicing and polyadenylation signals was ligated into the Sph I site of pMTI-2312 to yield plasmid pMTI-2314 (Figures 7a and 8b). Plasmid pMTI-2314 DNA was used as a minigene for the construction of APP-695 expressing transgenic mice as described in Example 11 below.

55 B. Minigene pMTI-2310

A second minigene for the expression of APP-695, pMTI-2310 (Figure 8a), was constructed according to the same four steps as outlined above for the construction of pMTI-2314, except that in the first step, an

-2.4 kb HindIII fragment derived from plasmid pMTI-3501 (Example 11 was inserted into the HindIII site of pMTI-2301 (part A above) to yield plasmid pMTI-2306. Diagnostic miniprep analysis of pMTI-2306 DNA digested with NotI and BamHI revealed fragments of -2.7, -0.9 and -0.6 kb. The subsequent three steps yielded plasmids pMTI-2308 (diagnostic minipreps with NotI and XhoI revealed fragments of -2.6, -2.3 and -1.6 kb), pMTI-2309 (diagnostic minipreps with HindIII to determine orientation revealed fragments of -3.4, -2.9 and -2.6 kb) and pMTI-2310 (diagnostic minipreps with EcoRI revealed fragments of -2.7, -2.4, -2.3, -1.1 and -0.9 kb), respectively. Plasmid pMTI-2310, containing the same APP-695 gene as pMTI-2314 but with a truncated regulatory region, was also used as a minigene for the construction of APP-695 expressing transgenic mice as described in Example 11 below.

EXAMPLES

Construction of Minigenes pMTI-2319 and pMTI-2320 for Expression of APP-770 and APP-751

Minigenes pMTI-2319 and pMTI-2320 (Figure 8a) for the expression of APP-770 and APP-751, respectively, were each constructed in a single step digestion and ligation procedure via a simple interchange of Accl-BglII fragments. Plasmid pMTI-3521 DNA (Example 3) encoding a full-length cDNA for APP-770 was digested with Accl and BglII. An -1.8 kb Accl-BglII fragment of pFC4-770 was ligated into the Accl and BglII sites of pMTI-2314 to yield pMTI-2319. Diagnostic miniprep analysis of pMTI-2319 DNA digested with Scal revealed fragments of -7.3 and -4.8 kb. A Scal site exists in the inhibitor encoding domains of APP-770 and APP-751. Similarly, plasmid pMTI-3524 DNA (Example 3) encoding a full-length cDNA for APP-751 was digested with Accl and BglII. An -1.75 kb Accl-BglII fragment of pMTI-3524 was ligated into the Accl and BglII sites of pMTI-2314 to yield pMTI-2320. Diagnostic miniprep analysis of pMTI-2320 DNA digested with Scal revealed fragments of -7.2 and -4.8 kb. Plasmids pMTI-2319 and pMTI-2320, containing a full-length cDNA for APP-770 and APP-751, respectively, were used as minigenes for the construction of APP-770 and APP-751 expressing transgenic mice as described in Example 12 below. Thus, the inhibitor encoding domains found in APP-770 and APP-751 may be inserted in the APP-695 sequence of pMTI-2314 by swapping sequence domains between the unique Accl and BglII sites.

EXAMPLE 6

Construction of pMTI-2321 and pMTI-2322 Minigenes for Expression of APP C-Terminal Frameshift Mutants

Minigenes pMTI-2321 and pMTI-2322 (Figure 8a) for the expression of a truncated APP protein were constructed by making frameshift mutations in the C-terminal region of the APP coding sequence. These frameshift mutations were made in the APP cDNA sequences immediately following the A4 coding region so as to bring a translation stop codon into the reading frame (i.e., in-frame termination) following the A4 peptide coding region. The resulting mutated sequence codes for a truncated APP species as exemplified by gene product IV shown in Figure 4b.

In vitro mutagenesis procedures described by Kunkel et al., 1987, Methods in Enzymol. 154: 367-382, were used to generate the frameshift mutants briefly summarized as follows. The starting material for the mutagenesis was plasmid pMTI4 DNA. Plasmid pMTI4 is the mutagenesis vector KS Bluescript (+) available from Stratagene into which the -2.3 kb NruI-SpeI fragment of pFC4 containing a segment of the APP-695 cDNA has been inserted. For this construction, pFC4 DNA was digested with NruI and SpeI, treated with Klenow, then blunt-end ligated into the SmaI site of SmaI-digested KS Bluescript(+) DNA to yield pMTI-4. Single-stranded pMTI4 DNA was prepared from E. coli CJ236 host cells, in which cells uracil replaces thymine in DNA. The DNA was then made double-stranded by in vitro DNA synthesis using one of three mutagenizing synthetic oligonucleotides described below as primer for a particular preparation. The heteroduplex DNA (one uracil-containing normal pMTI4 strand and one newly synthesized thymine-containing mutated strand) was used to transform E. coli MV1190 cells, in which cells the sequence of the thymine-containing mutated strand is selectively propagated because the uracil-containing wildtype strand is degraded. Miniprep plasmid preparations from such transformed E. coli colonies were screened for incorporation of the mutation by direct DNA sequence analysis. For sequence analysis, the primer was an oligonucleotide having the sequence from nucleotide position 1881-1897 of the APP cDNA. The sequence -200 nucleotides downstream of the primer was analyzed to confirm the mutated sequence. Those clones having the desired mutation of the APP coding sequence were used for preparative purification of mutant plasmid DNA by conventional methods, for use in the construction of truncated APP minigenes.

Three types of mutants (a, b, c) were generated which introduced premature translation termination signals in APP mRNA to yield truncated APP proteins. The wildtype (wt) and mutant sequences beginning at nucleotide position 2040 are shown with the termination codons underlined as follows:

5	wt (nucleotide SEQ ID NO:9/amino acid SEQ ID NO:10)										
		a		b		c					
	wt	GTC	GCC	GGT	GTT	GTC	<u>AIA</u>	GCG	ACA	GTC	<u>ATC</u> ...
10		Val	Gly	Gly	Val	Val	Ile	Ala			
	a (nucleotide SEQ ID NO:11/amino acid SEQ ID NO:12)										
	a	GTC	GCC	GTC	TTG	TCA	<u>IAG</u>	CGA	CAG	<u>TGA</u>	TCG...
15		Val	Gly	Val	Leu	Ser	*				
	b (nucleotide SEQ ID NO:13/amino acid SEQ ID NO:14)										
	b	GTC	GCC	GGT	GTT	GTC	TCA	<u>IAG</u>	CGA	CAG	<u>TGA</u>
20		TGC...	Val	Gly	Gly	Val	Val	Ser	*		
	c (nucleotide SEQ ID NO:15/amino acid SEQ ID NO:16)										
	c	GTC	GCC	GGT	GTT	GTC	<u>IAG</u>	CGA	CAG	TGA	TCG...
25		Val	Gly	Gly	Val	Val	*				

The synthetic oligonucleotides used for mutagenesis were:

30		(SEQ ID NO:17)
	a	5'-CATGGTGGGGCTGTTGTCATAGC-3' [23-mer, 2036-2059]
		(SEQ ID NO:18)
35	b	5'-GGCGGTGTTGTTGTCATAGCCACAG-3' [25-mer, 2042-2064]
		(SEQ ID NO:19)
	c	5'-GGCGGTGTTGTTGTCATAGCCACAGTGA-3' [24-mer, 2043-2067]

40 For mutant-a, one nucleotide (C) that is marked above the wildtype sequence with the letter "a", is deleted, generating two in-frame termination codons. The first in-frame termination codon in mutant-a is the codon for aa 40 of the A4 sequence. In mutant-a, amino acids 38, 39 and 40 are different than those of the wildtype sequence. For mutant-b, two nucleotides (TG) were inserted at the position marked above the wildtype sequence with the letter "b", generating two in-frame termination codons. The first in-frame
45 termination codon in mutant-b is after the codon for aa 41 of the A4 sequence. In mutant-b, aa 41 is different than that of the wildtype sequence. Mutant-b (also known as the +2 mutant) was utilized in the construction of plasmid pMTI-2321 described below. For mutant-c, one nucleotide (A) that is marked in the wildtype sequence shown above with the letter "c" is deleted, generating an in-frame termination codon in the reading frame directly following the codon for aa 40 of the A4 sequence. Mutant-c has been designated
50 mutant 40-1, and was utilized in the construction of plasmid pMTI-2322 described below.

The portion of APP-695 cDNA that contains the A4 coding sequence lies within an -0.7 kb BglII-ClaI fragment (corresponding to nucleotide position 1915-2620) that can conveniently be moved from one APP gene construct to another since BglII and ClaI each cleave APP-695 cDNA only once. The following steps were used to insert the mutated part of pMTI4 into another APP construct to generate minigenes for
55 expression of truncated APP proteins. In the first step, mutated pMTI4 DNA was digested with BglII and ClaI. The -0.7kb BglII-ClaI fragment was then isolated from a preparative agarose gel. In the second step, DNA from the other construct was digested with BglII and ClaI and then treated with CIAP. For the preparation of plasmids pMTI-2321 and pMTI-2322, this other construct was pMTI-2314 (Example 4)

allow determination of desired orientation. Then, other restriction endonucleases were chosen to confirm the integrity of the construction (e.g., no anomalous rearrangements). The resulting ~7.6 kb plasmid was designated pMTI-2316. Miniprep analysis with BamHI and EcoRI revealed fragments of ~6.8 and ~0.8 kb. In the next steps, pMTI-2316 DNA was digested with BamHI, then mixed with and ligated to the ~2.0 kb BamHI fragment of pFC4 to yield pMTI-2317 by transformation and selection as described above. Miniprep analysis of the ~9.6 kb pMTI-2317 DNA with HindIII revealed fragments of ~7.3 and ~2.2 kb. Insertion of this BamHI fragment provided a convenient SphI site along with a portion of 3' untranslated sequences so as to be a template for a messenger RNA transcript of stable size. In the final steps, an ~0.6 kb SphI fragment of pMTI-2304 containing SV40 splicing and polyadenylation signals was inserted at the SphI site of pMTI-2317 by appropriate restriction endonuclease digestion, ligation, transformation and selection as described above, to yield desired plasmid pMTI-2318. Miniprep analysis of pMTI-2318 DNA with EcoRI revealed fragments of ~2.9, ~2.7, ~2.0, ~1.1, ~0.9 and ~0.6 kb. Plasmid pMTI-2318 was utilized as a minigene for the construction of transgenic mice expressing a 42 aa A4 peptide.

15 EXAMPLE 8

Epitope Tagging of Recombinantly Expressed APP

Immunochemical studies of the subcellular localization and processing of alternative forms of APP, including APP-695, APP-770 and APP-751, and mutated forms of APP, using antibodies elicited to synthetic peptides and/or recombinant precursor proteins are difficult for the following reasons. Firstly, the APPs are highly conserved among species (mouse and rat 99%, human and rat 97.3%) and are ubiquitously expressed. In order to easily obtain adequate antibody production against a variety of APP peptides and recombinant proteins, a highly antigenic epitope of Chlamydia (Huguenel et al., 1989, Intl. Soc. Sex. Trans. Dis. Res., 8th Meeting, Copenhagen, Denmark, Abstract no. 22) was inserted into the APP sequence at either the Kunitz inhibitor domain or the extreme C-terminus of the protein to produce "tagged" APP cDNAs. Minigenes containing such tagged APP cDNA can be used to prepare transgenic mice, and the APP translation products in such mice can be detected using antibodies against this epitope.

The peptide sequence of the Chlamydia epitope is TVFDVITLNPTI. This epitope has been shown to be very antigenic as an isolated peptide and as part of a larger protein (Huguenel et al., supra; Baehr et al., 1988, Proc. Natl. Acad. Sci. USA 85: 4000-4004; Stephens et al., 1988, J. Exp. Med. 167: 817-831). Synthetic oligonucleotides were generated for the site-directed mutagenesis in the APP coding region to insert the sequences for the Chlamydia epitope by M13 "looping-in" experiments. The synthetic oligonucleotide:

(nucleotide SEQ ID NO:25/amino acid SEQ ID NO:26)

5' Aat II
GGCTGCTGTG GCGGGGGTCTA AAT AGT TGG GTT CAG AGT GGT GAC GTC AAA
 40 * I T P N L T I V D F
 GAC AGT GTT CTG CAT CTC CTC AAA GA 77-mer (CC-TAG)
V I N Q M Q B F F

45 was used to engineer pMTI-63 which carries a C-terminal addition of sequences encoding the Chlamydia epitope to APP695. The synthetic oligonucleotide:

(nucleotide SEQ ID NO:27/amino acid SEQ ID NO:28)

5' Aat II
G GGT ACT GGC TGC TGT TGT AGG AAT AGT TGG GTT CAG AGT GGT GAC GTC
 T S A A T T P I T P N L T I V D
 55 AAA GAC AGT AAC TCG AAC CAC CTC TTC C 77-mer (IC-TAG)
F V T V R V V E E

was used to engineer pMTI-35 which carries an addition of the amino acid sequences encoding the

Chlamydia epitope into the APP sequence of amino acid residue 289, where the (Kunitz) protease inhibitor-like domain is spliced into the APP-695 molecule.

Antibodies prepared against this Chlamydia epitope are useful to investigate the tissue, cellular and subcellular localization of tagged APP proteins *in vivo*, to study the biochemical properties and processing of APP in transfected animal cells including cell-sorting of transfectants, to study APP *in vitro* translation products and APP transformed *E. coli* products on Western-blots, and to follow processing of APP and its subcellular localization in transgenic animals. Such studies should permit the identification of the functional role of APP in normal individuals and in individuals with AD or DS. Minigenes pMTI-2324 and pMTI-2325 (Figure 8a) for the expression of APP-695 (IC-TAG) were each constructed in a single step digestion and ligation procedure via a simple interchange of *AccI* and *BglII* fragments. Plasmid pMTI-35 DNA was digested with *AccI* and *BglII*. An ~1.8 kb *AccI* a-*BglII* fragment of pMTI-35 was gel-purified and ligated either into the *AccI* and *BglII* sites of the gel-purified large DNA fragment of pMTI-2314 to generate pMTI-2325 (Figure 8a) or into the *AccI* and *BglII* sites of the gel-purified large fragment of pMTI-2323 to generate pMTI-2324 (Example 9, Figure 10a). Diagnostic miniprep analysis of pMTI-2324 DNA digested with *HindIII* revealed fragments of ~1.3, ~4.4 and ~7.7 kb. Diagnostic miniprep analysis of pMTI-2325 DNA digested with *AatII* revealed fragments of ~4.2, ~3.3, ~3.1, ~0.6 and ~.055 kb. In an analogous manner, the ~1.8 kb *AccI*-*BglII* fragment of pMTI-35 can be ligated into the *AccI* and *BglII* sites of the gel-purified large DNA fragment of pMTI-2329 (Example 9, Figure 14) to generate pMTI-2335.

20 EXAMPLE 9

APP Minigenes with Metallothionein-Derived Regulator or Processing Sequences

A. APP Minigenes with Metallothionein-Derived RNA Processing Signals

Minigenes utilizing RNA processing signals derived from an exogenous mouse gene might be more efficiently expressed in transgenic mice as compared with minigenes utilizing SV40-derived RNA processing signals as described in Examples 4-8 above. Therefore, alternate minigene constructs were generated in which RNA splicing and polyadenylation sequences of the mouse metallothionein gene were utilized. One source of the mouse metallothionein gene is plasmid pJYMMT(L) (alternatively designated pCL-28 or T25). Plasmid pJYMMT(L) is an ~12.4 kb genomic clone of the metallothionein gene described by Hamer and Walling, 1982, *J. Mol. App. Gen.* 1: 274-288. This alternate series of minigenes utilizing metallothionein RNA signals was constructed using pJYMMT(L). Many of these alternate minigenes were generated via fragment swaps using the minigenes containing SV40 RNA signals described in Examples 4-8.

35

1. Alternate Minigenes Expressing APP-695, APP-770 and APP-751

A minigene utilizing mouse metallothionein-I gene RNA processing signals (splicing and polyadenylation) and expressing APP-695 was constructed in a single step as follows. A Klenow- treated ~2.2 kb *BglII*-*EcoRI* fragment of pJYMMT(L) containing all of the mouse metallothionein-I genomic gene sequence except the promoter was inserted by blunt-end ligation into the *Clal* site of plasmid pMTI-2312 DNA (Example 4) that had been digested with *Clal* and treated with Klenow and CIAP to generate plasmid pMTI-2323 (Figure 10a and 10b). Plasmid pMTI-2323 was selected in a two-step screening procedure. First, transformant plasmids from the blunt-end ligation were screened by colony hybridization using the insert fragment (~2.2 kb *BglII*-*EcoRI*) of pJYMMT(L) labelled with ³²P as probe. Colony hybridization was used as a first step in screening a variety of constructs disclosed herein when the background of transformant plasmids that were vector alone (i.e., no insert) was high. In the second screening step, the desired plasmid was selected from those positively hybridizing colonies by miniprep analysis of restriction endonuclease digested DNA. For pMTI-2323 (~13.3 kb), miniprep analysis using *HindIII* revealed fragments of ~7.7, ~4.4 and ~1.3 kb.

Minigenes utilizing metallothionein RNA signals and expressing APP-770 or APP-751 can be constructed via *AccI*-*BglII* fragment exchanges (Figure 10a) with either pMTI-3521 or pMTI-3524 (Example 3) respectively. Specifically, the ~1.8 kb *AccI*-*BglII* fragment of pMTI-3521 was inserted into the *AccI*-*BglII* sites of pMTI-2323, replacing the ~1.5 kb *AccI*-*BglII* fragment of pMTI-2323, to generate plasmid pMTI-2331 (Figure 10a). For example, for pMTI-2331, pMTI-2323 DNA was digested with *AccI* and *BglII* and the ~11.8 kb fragment was gel-purified, treated with CIAP and ligated with the ~1.8 kb *AccI*-*BglII* fragment that was gel-purified from pMTI-3521 DNA. The ligation mixture was used to transform *E. coli* DH5 α cells. The desired plasmid, pMTI-2331 (~13.3 kb), was identified by miniprep analysis. Using *Scal*, miniprep analysis of pMTI-2331 revealed fragments of ~9.0 and ~5.0 kb.

2. Alternate Minigenes Expressing APP C-Terminal Frameshift Mutants

A minigene utilizing metallothionein RNA signals and expressing a truncated APP protein was constructed via a fragment swap using minigene pMTI-2322 (Example 6, Figure 8a) containing SV40 RNA signals. Specifically, the -0.7 kb BglII-Clal fragment of pMTI-2322 containing mutation 40-1 (Example 6), was inserted into pMTI-2312 (Example 4, Figure 7a), via ligation of the -0.7 kb fragment of pMTI-2322 with the -10.5 kb BglII-Clal fragment of pMTI-2312 (that had been gel-purified and treated with CIAP prior to ligation), to generate pMTI-2326a. Miniprep analysis of the -11.2 kb pMTI-2326a DNA using HindIII revealed fragments of -7.8 and -3.4 kb. Then, the -2.2 kb BglII-EcoRI metallothionein fragment of pJYMMT(L) was inserted into the Clal site of pMTI-2326a by blunt-end ligation to generate pMTI-2326. Miniprep analysis of the -13.4 kb pMTI-2326 DNA using HindIII revealed fragments of -7.7, -4.4 and -1.3 kb. Alternatively, plasmid pMTI-2326 can be constructed in a one-step fragment swap. Specifically, the -0.6 kb BglII-SpeI fragment of pMTI-2322 (Example 6, Figure 8a) can be inserted directly into pMTI-2323, replacing the -0.6 kb BglII-SpeI fragment of pMTI-2323 to generate pMTI-2326 (Figure 10a). Alternative minigenes can be generated by analogous BglII-SpeI fragment exchanges between pMTI-2323 and constructs encoding alternate truncated forms of APP-695 (Examples 6 and 7).

3. Alternate Minigenes Expressing C-100 (Plasmid pMTI-2327) and MC-100 (Plasmid pMTI-2337) APP Mutants

A minigene utilizing metallothionein RNA signals and coding for the mutation designated C-100 (gene product VI, Figure 4b) was generated by deleting the -1.8 kb NruI-BglII fragment of pMTI-2323 (this example, part A) with blunt-end ligation to generate plasmid pMTI-2327 (Figure 11a). Plasmid pMTI-2323 DNA was digested with NruI and BglII; the -11.5 kb fragment was gel-purified, treated with Klenow, ligated, and used to transform *E. coli* DH5 α cells. Transformant plasmids were screened by miniprep analysis and the desired plasmid pMTI-2327 was selected. Miniprep analysis of pMTI-2327 DNA using HindIII revealed fragments of -7.7, -2.6 and -1.3 kb. A translation initiation codon, ATG, directly precedes the first codon of the A4 sequences in C-100.

A minigene for expressing the mutation designated MC-100 (gene product V, Figure 4b) was also prepared from plasmid pMTI-2323 to generate pMTI-2337 (Figures 11a and 11b). Specifically, pMTI-2337 was generated by deleting the -1.7 kb KpnI-BglII fragment of pMTI-2323 via gel purification of the -11.6 kb fragment and ligating using a synthetic oligonucleotide linker, sp-spacer-A4. The linker sp-spacer-A4 was inserted between the KpnI site at position 207 and the BglII site at position 1915 in APP-695, and had the following sequence:

5' -GGACGGAGGA-3' 10-mer (SEQ ID NO:29)
3' -CATGCCCTGCCTCTAG-5' 18-mer (SEQ ID NO:30)

The two oligonucleotide sequences that comprise sp-spacer-A4 were synthesized (using an Applied Biosystems instrument and manufacturer's recommended methods, model no. 380A DNA synthesizer), kinased and annealed according to conventional methods before ligation with the gel-purified -11.6 kb KpnI-BglII fragment of pMTI-2323 to generate pMTI-2337. Miniprep analysis of pMTI-2337 DNA with HindIII revealed fragments of -7.7, -2.6 and -1.3 kb.

MC-100 requires the 17 residue signal peptide of APP to direct translation and insertion of the mutant protein into the membrane. The signal peptide will be cleaved and eliminated during the membrane insertion. The nucleotide and amino acid sequence of MC-100 is shown in Figure 12.

4. Alternate Minigene Expressing A4 Peptide (Plasmid pMTI-2341)

A minigene utilizing metallothionein RNA signals for expressing the A4 peptide (gene product VII or sp-A4, Figure 4b) was prepared by deleting the -11.6 kb KpnI-BglII fragment of plasmid pMTI-2326 (this example, part A.2) and ligating using the sp-spacer-A4 linker (described in part A.3 above) to generate plasmid pMTI-2341. Minigene pMTI-2341 generates sp-A4, which an A4 peptide linked to the APP signal sequence. The nucleotide and amino acid sequence of sp-A4 is shown in Figure 13.

B. APP Minigenes With A Metallothionein-Derived Promoter

The generation of transgenic mice which express APP (or derivatives of APP) in cells and tissues not normally expressing the gene may lead to dominant phenotypes. The new phenotypes may facilitate a better understanding of the function of APP. To this end, a series of minigenes was constructed which minigenes are under the regulation of the mouse metallothionein gene promoter (Figure 14).

5

1. Alternate minigenes expressing APP-695, APP-770 and APP-751

A minigene utilizing a metallothionein promoter and expressing APP-695 was constructed as follows. Plasmid pMTI-2301 DNA (Example 4) was digested with HindIII, treated with Klenow and CIAP. Plasmid pJYMMT(L) DNA (part A above) was digested with EcoRI. An ~4.0 kb EcoRI fragment was gel-purified, treated with Klenow and blunt-end ligated to the pMTI-2301 DNA treated as described above. The desired transformant plasmid was designated pMTI-2328 (~6.7 kb). In the next step, the pMTI-2328 DNA thus obtained was digested with BglII, treated with Klenow and CIAP, gel-purified and then blunt-end ligated to an ~2.8 kb gel-purified SmaI-HindIII fragment of pMTI-2314 (~11.8 kb, Example 4). Transformant plasmids were screened by miniprep analysis and the desired plasmid pMTI-2329 (Figure 14) was selected. Miniprep analysis of pMTI-2329 DNA using EcoRI revealed fragments of ~3.7, ~3.1 and ~2.7 kb.

Minigenes utilizing a metallothionein promoter from pMTI-2329 and expressing APP-770 or APP-751 are constructed via fragment swaps with pMTI-2319 (alternatively, pMTI-2331 or pMTI-2342) or pMTI-2320 (alternatively, pMTI-2345), respectively. Specifically, an ~7.4 kb AccI-SpeI fragment is gel-purified and ligated with an ~2.4 kb AccI-SpeI fragment of pMTI-2319 or pMTI-2330 to yield pMTI-2333 for APP-770 expression and pMTI-2334 for APP-751 expression, respectively.

2. Alternate Minigenes Expressing APP C-Terminal Frameshift Mutants

By a similar fragment swap, a minigene utilizing a metallothionein promoter and expressing a truncated APP protein is constructed. Specifically, an ~2.1 kb AccI-SpeI gel-purified fragment of pMTI-2322 (alternatively, pMTI-2343 or pMTI-2326) containing mutation 40-1 (Example 6) was ligated with the ~7.4 kb AccI-SpeI gel-purified fragment of pMTI-2329 described above.

3. Alternate Minigene Expressing MC-100 APP Mutants

An alternate minigene for the expression of the MC-100 mutation (part A above) using a metallothionein promoter may also be prepared. For example, the ~1.7 kb KpnI-BglII fragment of pMTI-2329 may be deleted via digestion with KpnI and BglII, then gel purification of the ~7.8 kb KpnI-BglII fragment and finally ligation with the sp-spacer-A4 (part A above). The desired plasmid is confirmed by sequence analysis.

EXAMPLE 10

APP Minigenes with Genomic APP-Derived RNA Processing Signals

40

APP minigenes utilizing RNA processing signals derived from the human APP gene might be more efficiently expressed in transgenic mice as compared with minigenes described in Examples 4-8 above utilizing SV40 derived RNA processing signals or minigenes described in Example 9 above utilizing metallothionein gene-derived signals. Therefore, minigene constructs were generated in which RNA polyadenylation signals of the human APP gene were utilized. The source of the human APP genomic sequences for these constructs was plasmid pVS-1. Plasmid pVS-1 is an ~4.3 kb genomic clone of the human APP gene which comprises an ~1.5 kb EcoRI genomic fragment inserted into the EcoRI site of pUC19 in the orientation shown in Figure 15a, so that the APP polyadenylation signal can be recovered as an ~1.3 kb SphI fragment. The ~1.5 kb EcoRI fragment encompasses the 3'-end of the terminal exon of human APP and the APP polyadenylation signal and was isolated as follows. A Charon 21A lambda library of human chromosome 21 DNA (available from the A.T.C.C. as accession no. LA21NS01) was screened for clones containing 3'-end genomic sequences with a small SmaI-SphI fragment (nucleotides 3102-3269) from plasmid pFC4 labelled as a probe. The nucleotide sequence of the ~1.5 kb APP genomic fragment is shown in Figure 16. An alternate series of minigenes utilizing APP RNA signals derived from pVS-1 were constructed. Many of these alternate minigenes were generated via fragment swaps using pNotSV2neo subclones of the APP constructs. These pNotSV2neo subclones were utilized for switching sequence domains via fragment swaps because of the presence of convenient PvuI and SpeI restriction enzyme sites. NotI fragments of many of the APP minigenes described in Examples 4-8 were subcloned into pNotSV2neo

55

(see Figures 17 and 18a) so that APP expression could be determined in transient transfections of COS cells (Gluzman, 1981, Cell 23: 175-182). Plasmid pNotSV2neo (Figure 17) was prepared by converting the unique BamHI site of pSV2-neo (available from the A.T.C.C. as accession no. 37149) to a NotI site using linkers (NEB catalog no. 1045). Plasmid pSV2-neo was digested with BamHI, treated with Klenow and CIAP, and ligated to NotI linkers as recommended by the supplier. The pNotSV2neo subclones of the APP constructs used in the preparation of alternate minigenes were prepared as summarized in Table I below and Figure 18a. The construction of each of the APP minigenes utilizing APP genomic RNA processing signals from pVS-1 listed in Table I is described below.

TABLE I

pNotSV2neo APP Subclones

<u>Subclone</u>	<u>APP Sequence</u>	<u>Insert in pNotSV2neo*</u>
pMTI-2360	APP-695	-10.6 kb <u>NotI</u> fragment of pMTI-2323
pMTI-2362	APP-695	-6.8 kb <u>NotI</u> fragment of pMTI-2329
pMTI-2369	APP-695	-9.8 kb <u>NotI</u> fragment of pMTI-2339
pMTI-2363	APP-770	-10.8 kb <u>NotI</u> fragment of pMTI-2331
pMTI-2368	APP-751	-9.2 kb <u>NotI</u> fragment of pMTI-2320
pMTI-2361	Mutation 40-1	-10.8 kb <u>NotI</u> fragment of pMTI-2326
pMTI-2364	MC-100	-8.0 kb <u>NotI</u> fragment of pMTI-2340
pMTI-2366	MC-100	-8.8 kb <u>NotI</u> fragment of pMTI-2337
pMTI-2365	Sp-A4	-8.8 kb <u>NotI</u> fragment of pMTI-2341
pMTI-2367	β -gal	-8.6 kb <u>NotI</u> fragment of pMTI-2402

* For preparation of the subclones, each insert was gel-purified and ligated into pNotSV2neo vector DNA that had been digested with NotI, gel-purified and treated with CIAP.

A. Alternate Minigenes Expressing APP-695, APP-770 and APP-751 (Plasmids pMTI-2339, pMTI-2342 and pMTI-2345)

The minigene construct designed to express APP-695 was generated by inserting an -1.3 kb SphI fragment from pVS-1 into the SphI site of pMTI-2312 (Example 4) to generate pMTI-2339 (Figures 15a and 15b). Minigene pMTI-2342 expressing the APP-770 alternate form of APP was generated by inserting the -6.9 kb PvuI-SpeI fragment of pMTI-2363 (Table I, Figure 18a) into the PvuI-SpeI fragment of pMTI-2369 (Figure 19). Plasmid pMTI-2369 was itself generated by inserting the -9.8 kb NotI fragment of pMTI-2339

into pNotSV2neo (Table I and Figure 19). Minigene pMTI-2345 expressing the APP-751 alternate form of APP was generated analogously by inserting the -6.9 kb PvuI-SpeI fragment of pMTI-2368 (Table I) into the -8.8 kb PvuI-SpeI fragment of pMTI-2369 (Table I).

5 **B. Alternate Minigenes for Expressing C-Terminal Frame shift Mutants**

1. Mutant 40-1 (Plasmid pMTI-2343)

Minigene pMTI-2343 expressing the 40-1 frameshift mutant was generated by a fragment swap. The
10 -6.7 kb PvuI-SpeI fragment of pMTI-2361 (Table I, Figure 18a) was inserted into pMTI-2369 (Figure 19).

C. Alternate Minigene For MC-100 Mutant

Minigene pMTI-2340 expressing the MC-100 deletion mutant was generated by deleting an -1.7 kb
15 KpnI-BglII fragment of pMTI-2339 (Figures 15a and 15b) and ligating using the sp-spacer-A4 synthetic linker described in Example 9 above.

D. Alternate Minigene for A4 Peptide

20 Minigene pMTI-2344 expressing the A4 peptide was generated by a fragment swap (Figure 19). The -5.0 kb PvuI-SpeI fragment of pMTI-2365 (Table I, Figure 18a) was inserted into the -8.8 kb PvuI-SpeI fragment of pMTI-2369 (Figure 19).

EXAMPLE 11

25

Preparation and Analysis of Transgenic Mice Expressing APP Minigenes

Transgenic mice are mice that contain exogenous DNA integrated into their genomes (Gordon and Ruddle, 1981, *Science* 214: 1244-1246). The DNA thereby integrated is called a transgene. APP minigenes
30 prepared as described in Examples 4-10 may be used to prepare corresponding transgenic mice expressing these transgenes. The technical aspects of the procedure for preparing transgenic mice have been the subject of extensive review by Gordon and Ruddle, 1983; *Methods Enzymol.* 101C: 411-433, and Hogan et al., 1986, *Manipulation of the Mouse Embryo; A Laboratory Manual*, Cold Spring Harbor Lab., Cold Spring Harbor, NY, and are hereby incorporated by reference.

35 The general procedure involves gene transfer by microinjection. Fertilized 1-cell mouse embryos are dissected from superovulated female mice [strain: Hsd:(ICR)BR] mated with male mice (strains: Hsd:(ICR)BR or B6D2F₁/HsdBR). Transgenic mice generated from a homozygous, or inbred, strain of mice are created using embryos from C57BL/6NHsdBR mating partners. Embryos are cultured *in vitro* as described in Hogan et al. (*supra*). Microinjections were performed as described in DePamphilis et al., (*supra*).
40 Approximately 100 to 500 copies of a linear NotI fragment (-6-11 kb in size) of an APP minigene (listed in Table II) are loaded into a microinjection pipet and expelled into one of the pronuclei of a 1-cell mouse embryo. Approximately 1 to 3 pl of DNA injection fragment solution (approximately 5-10 μ g/ml linear DNA, 0.3 mM EDTA, and 10mM Tris pH 7.5) is injected into a pronucleus of each 1-cell embryo. During injection, mouse embryos are held in-place by a microscopic cell holder. Surviving embryos were then surgically
45 reimplanted into pseudo-pregnant foster mice (strain: Hsd:(ICR)BR) as described in DePamphilis et al. (*supra*) and Hogan et al. (*supra*). Progeny mice are born approximately 19 days post-implantation and approximately 10-30% of the progeny are transgenic (i.e., their chromosomes carry one or more copies of the injected APP minigene) and are designated as transgenic founders. Positive transgenic mice are designated by either Southern-blot or PCR analysis of tail-biopsy DNA (See below). Transgenic founder
50 mice are bred with appropriate partners, strain: Hsd:(ICR)BR for outbred strain background, or C57BL/6NHsdBR) for inbred strain background, to generate heterozygote F1 progeny. Transgenic siblings (F1) are then inbred to generate a homozygous (for transgene) line of mice. Glass cell-holders are constructed using borosilicate glass capillaries (1mm od. and 0.58mm id.; from Sutter Instruments Co., San Rafael, CA, part #B100-58-15) on a microfuge (de Fonbrune-type; Technical Products International Inc., St. Louis, MO). The tips of the cell-holders are fire-polished and have a diameter of approximately 50 microns.
55 Microinjection pipets are beveled and have a diameter of approximately 2 microns at their terminus. To make microinjection pipets, glass capillaries (1mm od. and 0.78mm id.; from Sutter Instruments Co., part #B100-78-15) were pulled on a Sutter Instruments Co. micropipet puller (model #P-80/PC) and then the tips

were beveled on a Sutter micropipet beveler (model #BV-10; bevel angle approximately 25° to 30°). Pulled pipets are siliconized by incubation in a glass chamber saturated with hexamethyldisilazane (HMDS; Pierce #84769) for approximately 8 hours at room temperature. Microinjections are performed on a Zeiss IM-35 inverted microscope using Nomarski optics. Microinjection pipets and cell holders are controlled using
 5 Narishigi (Japan) micromanipulators (model #MO-102M and #MN-2). The flow of the injection solution in microinjection pipets is controlled using an Eppendorf Microinjector (model #5242). Surgical reimplantations are performed using a Zeiss SV8 dissection microscope.

DNA injection fragments were isolated from vector sequences by NotI digestion and agarose gel electrophoresis. Linear DNA fragments were recovered from the agarose gels by electrophoresis onto a
 10 NA45 membrane (Schleicher and Schuell, catalog no. 23410). The NotI linear DNA fragment was recovered from the membranes according to the manufacturer's instructions. Ethidium bromide was extracted from the DNA solution using isopropanol (buffer saturated, 1 mM EDTA and 10 mM Tris pH 7.6). DNA was precipitated by addition of a half volume of 7.5 M ammonium acetate and then by 2.4 volumes of absolute ethanol. The DNA pellet was resuspended in TE buffer (1 mM EDTA and 10 mM Tris pH 7.6) and then
 15 reprecipitated in ammonium acetate and ethanol as described above. DNA was reprecipitated a total of three to four times. DNA injection fragments were finally resuspended in injection buffer (0.3 mM EDTA, and 10 mM Tris pH 7.5). DNA concentration of the fragment was estimated by ethidium bromide staining on diagnostic agarose gels against known concentrations of DNA as standards. Fragments obtained in this manner were diluted to a concentration of 5 µg/ml.

20 Positive transgenic mice are identified by either Southern-blot or PCR analysis of tail-biopsy DNA. Southern-blot analysis is performed as described in Wirak et al., 1985, Mol. Cell Biol. 5: 2924-2935 and Mariatis et al. (supra). PCR analysis of tail-biopsy DNA is described below.

Tail biopsies are performed by dissecting approximately 1 cm of mouse tail from each mouse. Tail segments are cut into small fragments and incubated in 1.0 ml of tail extraction buffer (0.5 mg/ml proteinase
 25 K, 0.5% SDS, 100 mM EDTA, and 50 mM Tris pH 8.0) at 55° C for 12 to 16 hours. Samples are then extracted with 1.0 ml phenol (equilibrated with 1 mM EDTA and 10 mM Tris pH 7.6). The samples were further extracted with addition of 1.0 ml of CIA (chloroform: isoamylalcohol; 24:1). Samples are centrifuged at 10,000 x g for 10 minutes at room temperature and 0.7 ml of the aqueous phase is transferred to an Eppendorf tube. DNA is precipitated at room temperature by addition of 0.07 ml sodium acetate, pH 6.0,
 30 and 0.7 ml 100% ethanol. DNA is pelleted by centrifugation at 12,000 x g for 2 minutes at room temperature. Ethanol is decanted and DNA pellets are washed with 1.0 ml 70% ethanol and samples are centrifuged at 12,000 x g for 1 minute at room temperature. DNA pellets are dried in vacuum and resuspended in 0.05 ml TE (1 mM EDTA and 10 mM Tris pH 7.6). Samples are incubated at 55° C for 5 minutes and then refrigerated overnight to rehydrate DNA. DNA concentrations were determined by reading
 35 absorbance at 260 nm in a spectrophotometer.

PCR analysis of tail-biopsy DNA was performed using two sets of oligonucleotides; one set (either oligonucleotides #11 and #12 or #40 and #41) which generates a 322 bp or 320 bp DNA fragment, respectively. These oligonucleotides amplify DNA sequences specifically from human APP minigenes. A
 40 second set of oligonucleotides (oligonucleotides #6 and #7) is included with each reaction which serves as an internal control for the PCR reaction and which amplifies a 154 bp DNA fragment from the mouse ribosomal protein L32 gene (Dudov and Perry, 1984, Cell 37: 457-468). The sequences of the oligonucleotides are as follows:

45 oligonucleotide #6 (SEQ ID NO:31):
 5'-CCTCGGCCTTTGGTGTGTGTTTTATATGACATGACCCCTTGA-3'
 oligonucleotide #7 (SEQ ID NO:32):
 5'-CACCCCTGTTGTCAATGCCTCTGGGTTCCGCCAGTTTCG-3'
 50 oligonucleotide #11 (SEQ ID NO:33):
 5'-ATGAACTTCATATCCTCAGTCCATGTCGGAATTCT-3'

55

oligonucleotide #12 (SEQ ID NO:34) :

5'-GGCAACATGATTAGTGAACCAAGG-3'

5

oligonucleotide #40 (SEQ ID NO:35):

5'-GGAGGGTGCTCTGCTGGTCTTCAATTACC-3'

10

oligonucleotide #41 (SEQ ID NO:36):

5'-AAGCGTTTGTCCAGGCATGCCTTCCTCATCC-3'

The PCR reaction conditions are: 50 μ g/ml DNA, 5.0 μ g/ml of each oligonucleotide, 25 units/ml Taq polymerase (Cetus), 0.2 mM dATP, 0.2 mM dGTP, 0.2 mM dCTP, 0.2 mM TTP, 50 mM KCl, 1.5 mM MgCl₂, 0.01% gelatin, and 10 mM Tris pH 8.3. In many cases the oligonucleotides are end-labelled with ³²P using polynucleotide kinase as described in Example 13. The specific activity of each oligonucleotide is approximately 2 x 10⁵ cpm/ μ g. The PCR reactions are performed in a Perkin Elmer DNA thermal cyclor using the following reaction cycles (files): twenty-one cycles of 1 minute at 94 °C, then 2 minutes at 55 °C, then 3 minutes at 72 °C with an auto extension for sequence 3 of 10 seconds/cycle, followed by a cycle of 1 minute at 94 °C, then 2 minutes at 55 °C, then 12 minutes at 72 °C with an auto extension for sequence 3 of 10 seconds/cycle. The samples are then maintained at 18 °C until removal from thermal cyclor. DNA fragments are separated by electrophoresis on a 5% polyacrylamide gel and visualized by either staining with ethidium bromide or by radioautography.

Table II shows a number of APP minigene constructs useful for the preparation of transgenic mice. Table III shows a listing of representative APP transgenic founder mice generated according to the above-described methods. The transgenic founder mice are bred to establish permanent strains as described above. Table III also summarizes RNA and protein expression of APP minigenes in various transgenic mice as described in Examples 12, 13, 14 and 15.

30

35

40

45

50

55

TABLE II
APP MINIGENE CONSTRUCTS

	<u>Construct</u>	<u>Promoter and Genomic Regulatory Elements</u>	<u>APP cDNA Sequences</u>	<u>Splicing and/or Poly-Adenylation Signals</u>
5	pMTI-2310	-2.4kb <u>HindIII</u> (APP)	APP-695 (pFC4)	SV40
10	pMTI-2314 pMTI-2319 pMTI-2320 pMTI-2321	-4.6kb <u>EcoRI</u> (APP)	APP-695 (pFC4) APP-770 (pFC4-770) APP-751 (pFC4-751) APP-695 +2 frame	
15	pMTI-2322		shift APP-695 - mutant	
	pMTI-2325		40-1 APP-695 + <u>Chlamydia</u>	
20	pMTI-2318		antigen A4	
	pMTI-2323	-4.6kb <u>EcoRI</u> (APP)	APP-695 (pFC4)	Mouse metallo- thionein
25	pMTI-2331 pMTI-2332 pMTI-2324		APP-770 APP-751 APP-695 + <u>Chlamydia</u>	
30	pMTI-2326		antigen APP-695 - mutant	
	pMTI-2327 pMTI-2337 pMTI-2341		40-1 C-100 MC-100 A4	
35	pMTI-2329	-2.2 kb <u>EcoRI/BglII</u> mouse metallothionein	APP-695 (pFC4)	Mouse metallo- thionein
40	pMTI-2333 pMTI-2334 pMTI-2335		APP-770 APP-751 APP-695 + <u>Chlamydia</u>	
45	pMTI-2336 pMTI-2330		antigen APP-695 - mutant 40-1 APP mutant 40 - alternative con- struct	
50				
55				

	<u>Construct</u>	<u>Promoter and Genomic Regulatory Elements</u>	<u>APP cDNA Sequences</u>	<u>Splicing and Poly-Adenylation Signals</u>
5	pMTI-2339	-4.6kb <u>EcoRI</u> (APP)	APP-695	APP 3'-end
	pMTI-2342		APP-770	
	pMTI-2345		APP-751	
	pMTI-2343		Mutant 40-1	
10	pMTI-2340		MC-100	
	pMTI-2344		sp-A4	

TABLE III
Transgenic Mouse Strains with Human APP Minigenes

	<u>Constructs</u>	<u>Strain Designation</u>	<u>Transgenic Founders</u>	<u>Gene Expression (brain)</u>	
				<u>RNA</u>	<u>Protein</u>
20	pMTI-2401	HB	HB805	.	.
			HB909	.	.
			HB1002	.	.
	pMTI-2402	BE	BE803	.	+
25			BE1805	.	+
			BE3002	.	+
	pMTI-2310	DH	DH106	+	.
			DH108	.	.
			DH110	.	.
			DH409	.	.
30			pMTI-2314	ED	ED106
	ED801	+			.
	ED803	.			.
	ED1001	+			.
	pMTI-2318	AE	AE101	++	.
35			AE201	+	.
			AE601	+	.
			AE301	++	.
			AE302	.	.
	pMTI-2319	JE	JE711	+	.
			JE1005	.	.
40			JE1308	.	.
			IE205	.	.
	pMTI-2320	IE	IE206	+	.
			IE301	+	.
			IE302	.	.
			IE504	+	.
45			IE505	.	.
			IE508	.	.
			IE602	.	.
			IE606	+	.
			IE608	.	.
			IE801	++	+
50	pMTI-2321	FE	FE403	++	.
			FE803	+	.
			FE805	.	.
			FE1001	+	.
55	pMTI-2322	GE	GE106	.	.
			GE107	.	.

	<u>Constructs</u>	<u>Strain Designation</u>	<u>Transgenic Founders</u>	<u>Gene Expression (brain)</u>	
				<u>RNA</u>	<u>Protein</u>
5	pMTI-2323	DM	DM101	++	.
			DM301	.	.
			DM309	-	.
			DM405	+	.
			DM407	.	.
10			DM406	+	.
			DM606	+	.
			DM706	.	.
			DM1007	.	.
			DM1102	.	.
			DM1107	.	.
15	pMTI-2329	DL	DL110	.	.
			DL413	.	.
			DL413	.	.
	pMTI-2331	JM	JM201	.	.
			JM316	.	.
20	pMTI-2344	SA	SA110	.	.
			SA602	.	.
			SA706	.	.
	pMTI-2343	FA	FA105	.	.
			FA201	+	.
			FA501	.	.
25			FA510	.	.
			FA1001	.	.
			CA507	.	.
	pMTI-2340	CA	CA408	.	.
			CA507	+	.
			CA1102	.	.
30			CA3603	.	.
			CA3701	.	.
			CA3704	.	.
			CA4402	.	.
			CA4404	.	.
35	pMTI-2342	JA	JA407	++	+
			JA1301	++	+
			JA1302	.	.

+ EXPRESSION
 - EXPRESSION NOT WITH LIMITS OF DETECTION
 . NOT DETERMINED

EXAMPLE12

Tissue-Specific Expression of APP Minigene In Transgenic Mice Using the lacZ Reporter Gene

The design of recombinant minigenes is a critical step in the generation of a transgenic mouse model for A4-amyloidosis. An essential element is a gene-regulatory region required for tissue-specific gene expression. Minigene constructs should exhibit expression patterns in transgenic animals which are consistent with the occurrence of amyloid in AD brains and preferentially resemble expression patterns of the endogenous mouse APP gene. For this purpose, the human APP gene regulatory region was isolated as described in Example 1, and utilized for the construction of APP minigenes. To monitor the tissue specificity of this human regulatory element in transgenic mice, a reporter gene, *E. coli* lacZ, encoding β -galactosidase was utilized. This reporter gene allows for the convenient histochemical localization of protein expression regulated by the human APP gene regulatory region. Using this reporter gene, the 5'-end sequences of the human APP gene were demonstrated to contain sufficient information to target expression in the CNS of transgenic animals with patterns consistent with endogenous mouse APP gene expression as

follows.

The minigene pMTI-2402 (Figure 20) was constructed by fusing the ~4.6 kb EcoRI fragment described in Example 1 comprising the human APP gene regulatory region including the APP promoter, with the lacZ reporter gene in the following steps. First, the cloning vector pMTI-2301 was prepared. Plasmid pMTI-2301 contains a unique HindIII cloning site, flanked by NotI restriction sites, and was constructed as described in Example 4. Second, the ~4.6 kb EcoRI fragment isolated from the chromosome 21 library as described in Example 1 encompassing the 5'-end of the human APP gene was inserted by blunt-end ligation into the HindIII site of pMTI-2301 to generate pMTI-2307. Finally, minigene pMTI-2402 containing the lacZ gene was constructed by inserting an ~3.9 kb HindIII-BamHI fragment from plasmid pCH126, containing the lacZ fusion protein and SV40 polyadenylation signal, into the NruI site of pMTI-2307 by blunt-end ligation. Plasmid pCH126 is identical to plasmid pCH110 described by Hall et al., 1983, J. Mol. Appl. Gen. 2: 101-109, except that the SV40 promoter (the PvuII-HindIII fragment. See Figure 1 in Hall et al., 1983, J. Mol. Appl. Gen. 2: 101-109.) has been deleted but the HindIII site remains. (Goring et al., 1987, Science 235: 456-458).

Plasmid pMTI-2402 DNA was double-purified in CsCl/ethidium bromide equilibrium density gradients. The ~8.6 kb linear DNA fragment, encompassing the APP/lacZ reporter gene, was excised from vector sequences using NotI and isolated from an agarose gel using NA45 paper (Schleicher and Schuell, Keene, NH). The DNA was precipitated in ethanol-ammonium acetate three times and resuspended, at a concentration of 6 µg/ml, in filtered (0.2 µ membrane) injection buffer (10 mM Tris, pH 7.5, and 0.3 mM EDTA; Brinster et al., 1985, Proc. Natl. Acad. Sci. USA 82: 4438-4442). Purified DNA fragments were microinjected into 1-cell embryos of Hsd:(ICR)BR female mice and B6D2F₁/Hsd BR male mice and reimplanted into Hsd:(ICR)BR female mice as described (DePamphilis et al., 1988, BioTechniques 6: 662-680). Transgenic founder mice were identified by PCR analysis of tail biopsy DNA using 30 bp oligonucleotides #15 and #16, complementary to the E. coli lacZ gene and internal control oligonucleotides #6 and #7 (described in Example 11). The sequence of oligonucleotides #15 (SEQ ID NO:37) and #16 (SEQ ID NO:38) are as follows:

```

#15  5' - CCTGGCGTTACCCAACTTAATCGCCTTGCAGGACAT - 3'
#16  5' - AATAAATCTGACGGAGTAACAACCCGTCGGATTCT - 3'

```

DNA from transgenic mice was further analyzed by restriction enzyme digestion and Southern-blot analysis (Wirak et al., 1985, Mol. Cell. Bio. 5: 2924-2935).

A. In situ hybridization

In situ hybridization techniques were used to establish the cellular distribution of APP mRNA in normal mice. The distribution of APP mRNA within the central nervous system (CNS) of other species (humans, primates, rats) has been previously determined with the majority of the CNS APP mRNA localized to neuronal cytoplasm. For these experiments, four-to-five-week-old mice were anesthetized and perfused with 4% paraformaldehyde in 0.08 M phosphate buffer, pH 7.6. The following tissues were removed and processed to paraffin by standard procedures: cerebral hemispheres plus diencephalon, pons, medulla, cervical and lumbar spinal cord, trigeminal nerve, and liver. All tissues from individual mice were embedded in a single block. Sections were cut at a thickness of 6 µm and hybridized according to published procedures (Trapp et al., 1987, Proc. Natl. Acad. Sci. USA 84:7773-7777; Trapp et al., 1988, J. Neuro Sci. 8: 3515-3521). Briefly, pre-hybridization treatment consisted of 0.2 N HCl for 20 minutes and 25 µg/ml protease K for 15 minutes at 37° C. Slides were hybridized at room temperature for 16 hours in a standard buffer containing 0.2 ng/µl of single-stranded, full-length human APP cDNA, labeled with ³⁵S by the Klenow procedure (specific activity, 2.3 x 10⁹ cpm/µg). Stringency washes included 50% formamide containing 0.3 M NaCl, 1 mM EDTA, and 5 mM Tris (pH 8.0) for 30 minutes at room temperature and 2 X SSC (1 X SSC = 0.3 M NaCl, 0.03 M sodium citrate, pH 7.4) in 1 mM EDTA for one hour at 55° C. Slides were then dehydrated, air dried, dipped in emulsion (Kodak, NTB-3), exposed for 7 days, developed for autoradiography and counter-stained with hematoxylin. Sections were photographed with a Zeiss Axiophot using dark-field and bright-field optics. Specific brain regions and neuronal subpopulations were identified according to published criteria (Sidman et al., 1971, Atlas of the Mouse Brain and Spinal Cord, Harvard University Press, Cambridge, MA). Silver grains, representing APP mRNA, occurred in clusters that reflected the general distribution of neurons in all brain regions studied (Figure 21). For example, neuronal perikarya present in

the pyramidal layer of the hippocampus and granular layer of the dentate gyrus were labeled intensely (Figure 21a). Significantly less hybridization signal was detected in other layers of the hippocampal formation in subcortical white matter. The cerebral cortex contained significant levels of APP mRNA (Figure 21a); and the labeling pattern in various cortical areas (i.e., occipital, temporal, and frontal) reflected the distribution of neuronal perikarya in the various layers. Layer I, which contains few neurons, had the lowest hybridization signal in all cortical regions. In sections of cerebellar cortex, Purkinje and granular cells were labeled by APP cDNA (Figure 21b). Sections of trigeminal ganglia (from peripheral nervous system) were hybridized with APP cDNA and the neuronal perikarya, which occur in clusters, were labeled intensely but little hybridization signal was found in myelinated fiber tracts in the PNS (Figure 21c). APP mRNA was not detected in sections of liver (Figure 21d), a finding consistent with Northern-blot analysis (Yamada et al., 1989, *Biochem. Biophys. Res. Commun.* 158: 906-912). The distribution of silver grains was concentrated within perinuclear cytoplasm of neurons (Figure 21e). Few silver grains were present over neuronal nuclei or scattered throughout the neurophil.

15 B. Histochemical Detection of β -Galactosidase

For the light microscopic histochemical detection of β -galactosidase in the transgenic mice carrying the APP/lacZ reporter gene, transgenic mice and normal mice as controls, four-to-five-weeks of age, were anesthetized and perfused with 4% paraformaldehyde and 0.08 M phosphate buffer, pH 7.6. The CNS, trigeminal nerve, and liver were removed and placed in the fixative overnight at 4°C. These tissues were cut into 0.5 cm thick slices that were either stained histochemically for β -galactosidase or sectioned at a thickness of 20 μ m on a vibrating microtome prior to staining.

β -galactosidase activity was detected histochemically by incubating the tissue in a reaction buffer [2.7 mM KH_2PO_4 , 8.0 mM $\text{Na}_2\text{HPO}_4 \cdot 7\text{H}_2\text{O}$, pH 7.6, 2.7 mM KCl, 140 mM NaCl, 2 mM MgCl_2 , 22.5 mM $\text{K}_4\text{Fe}(\text{CN})_6$, 25.0 mM $\text{K}_3\text{Fe}(\text{CN})_6$, 0.27 mg/ml sodium spermidine, 0.5 mg/ml X-gal (20 mg/ml stock in diethylformamide), 0.02% NP-40, and 0.01% sodium deoxycholate] that was maintained at 30°C for 18 to 24 hours. Vibratome sections were infiltrated with 100% glycerol, mounted on glass slides, and then photographed with a Zeiss Axiophot microscope using bright-field or Nomarski optics.

The tissue and cellular expression pattern of an APP promoter-lacZ reporter gene in adult transgenic mice as determined by the above-described histochemical method was strikingly similar to the distribution of endogenous mouse and endogenous human APP mRNA. Minigene pMT1-2402, for the expression of the reporter gene in transgenic mice, was constructed as described above by inserting sequences encoding a lacZ fusion protein and SV40 polyadenylation signals into an -4.5 kb genomic fragment encompassing the 5'-end of the human APP gene. The genomic fragment contains 2831 bp of sequences 5' to the primary transcriptional start site, exon I, and approximately 1.6 kb of the first intron. Three lines of transgenic mice were identified which carried multiple head-to-tail integrations of the intact reporter gene (Table III). Tissue distribution analysis of the three lines showed that one line, BE803, exhibited intense β -galactosidase expression throughout the CNS, while two lines (BE1805 and BE3002) exhibited lower levels of expression.

In adult BE803 mouse brain, staining was concentrated in regions having high concentrations of neuronal perikarya (Figures 22 and 23a-c). Thus, cerebral cortex, dentate gyrus, basal ganglion, thalamus, and regions of the hippocampus were stained intensely. Prominent white matter tracts such as the corpus callosum and internal and external capsule were not stained. Staining of brain stem and spinal cord tissue was observed in a pattern similar to endogenous mouse APP mRNA. β -galactosidase was not detected in slices of normal mouse brain, used as a control (Figure 23d).

Regions of cerebellar cortex that contain high concentrations of neuronal perikarya were positive for β -galactosidase (Figures 24a and 24b) as were neuronal perikarya in the trigeminal ganglion. White matter tracts in the cerebellum and trigeminal nerve (Figure 24c), and slices of liver (Figure 24d) from BE803 mice were negative for β -galactosidase. Identical β -galactosidase staining patterns were observed in tissue slices from several BE803 transgenic mice. The cellular and subcellular distribution of β -galactosidase was determined in several brain regions by light microscopic procedures. β -galactosidase was localized histochemically in 20- μ m-thick vibratome sections. In these sections, β -galactosidase reaction product occurred as small dots that were restricted to regions of the CNS that contained neuronal perikarya. Reaction product was detected in all layers of the cerebral cortex (Figure 25a), including occasional deposits in Layer I. When examined at higher magnification with Nomarski optics, β -galactosidase reaction product was restricted to perinuclear regions of neurons (Figures 25b and 25c). β -galactosidase was not detectable in endothelial cells and cellular perikarya within white matter tracts. In the cerebellar cortex, β -galactosidase was localized in perinuclear regions of Purkinje cells (Figure 24b). Analysis of vibratome sections also detected the presence of β -galactosidase in regions of the CNS that were not labeled

intensely in the brain slices. For example, consistent but weak staining of some but not all neurons in CA-3 region of the hippocampus was found.

C. Immunocytochemical Detection of β -Galactosidase

5 For the electron microscope (EM) immunocytochemical detection of β -galactosidase, transgenic mice, between four-to-five-weeks of age, were perfused with 2.5% glutaraldehyde and 4% paraformaldehyde in 0.08 M phosphate buffer. The brains were removed and placed in the fixative overnight at 4 °C. Segments of the cerebral cortex (2 mm²) were infiltrated with 2.3 M sucrose and 30% polyvinyl pyrrolidone, placed on
10 specimen stubs, and frozen in liquid nitrogen. Ultrathin frozen sections (~120 nm-thick) were cut in a Reichert Ultracut-FC4 ultracyromicrotome maintained at approximately -110 °C. The sections were transferred to formvar and carbon-coated hexagonal mesh grids and stained by immunogold procedures using a modification of standard procedures. Following immunostaining, the grids were placed in PBS containing 2.5% glutaraldehyde for 15 minutes and rinsed. The sections were stained with neutral uranyl acetate
15 followed by embedding in 1.3% methylcellulose containing 0.3% uranyl acetate. Grids were examined in a Hitachi H600 electron microscope.

The cellular and subcellular distribution of β -galactosidase in the cerebral cortex and other brain regions as determined by the immunogold procedure revealed that the majority of gold particles in electron micrographs was localized to the perinuclear cytoplasm of neurons (Figure 25d). Glial cells and endothelial
20 cells were not labeled.

The striking conclusion from the *in situ* hybridization, light microscopic and electron microscopic detection of mouse APP and β -galactosidase was that the -4.5 kb genomic fragment encompassing the 5'-end of the human APP gene isolated as described in Example 1 had sufficient sequence information to direct cell- and tissue-specific expression of a reporter gene, *E. coli lacZ*, in transgenic mice. The
25 expression pattern of the reporter gene in the CNS was strikingly consistent with the expression pattern of the endogenous mouse APP gene. This -4.5 kb genomic fragment which includes the APP promoter and perhaps other regulatory elements was incorporated in nearly all APP minigene constructs described in Examples 4-10 above. Such constructs are particularly useful in the preparation of transgenic mice as described in Example 11. The identification of such an appropriate gene promoter and other regulatory
30 elements for minigene constructs is a critical step for the development of transgenic mouse models for AD, since AD pathology is restricted to specific regions of the brain [Price, 1988, *Annu. Rev. Neurosci.* 9: 489-512]. The -4.5 kb genomic fragment described and characterized herein is the type of regulatory element that must be utilized to facilitate the expression of recombinant APP genes with a cell and tissue specificity that is consistent with the formation of amyloid plaque and the expression patterns of the APP gene.

35

EXAMPLE 13

Expression of Human APP mRNA in Transgenic Mice

40 Several transgenic mouse lines express human APP mRNA in brain tissue (Figures 26, 27, and 46). Expression of human APP mRNA in transgenic animals was determined by nuclease S1 protection analysis (Figures 26 and 27) and by riboprobe analysis (Figure 46).

A. Nuclease S1 Protection Analysis

45

S1 nuclease digests single-stranded DNA and RNA but not double-stranded species. Therefore, specific ³²P-labeled oligonucleotides that hybridize with complementary mRNA sequences, are protected from digestions by S1 nuclease and can be identified by denaturing polyacrylamide gel electrophoresis (PAGE). A human specific oligonucleotide (designated oligonucleotide #29 and described below) will produce an
50 approximately 70 bp-protected fragment in an S1 digestion when annealed to human APP mRNA. A mouse-specific oligonucleotide (designated oligonucleotide #30 and described below) will produce an approximately 50 bp-protected fragment when annealed to mouse APP mRNA in an S1 assay. RNA from the human cell line, HeLa (A.T.C.C. No. CCL2) was used for a positive control for human APP RNA (HeLa cells express APP; Weidemann et al., 1989, *Cell* 57: 115-126) and RNA from a control non-transgenic mouse was
55 used for a negative control in the assay.

Oligonucleotides complementary to either human (oligonucleotide #29) or mouse (oligonucleotide #30) APP mRNA sequences were synthesized using an automated Applied Biosystems oligonucleotide synthesizer (model 380A). Oligonucleotides were generated using reagents and protocols provided by the

manufacturer. The sequence of oligonucleotide #29 (SEQ ID NO:39) is:

5' -GAGATAGAATACATTACTGATGCTGCGATTAAATTCAGTTCAGCCATCTACTTGTGTTACA
GCACAGCTGGCGTCCATA -3'

This 80 bp oligonucleotide contains a 10 bp non-homologous sequence domain at the 3'-end so that, after S1 digestion, the protected oligonucleotide fragment (approximately 70 bp) can be distinguished from non-hybridized oligonucleotide probe. The actual size of the protected fragment(s) can only be determined by experimentation because specific single- and double-stranded nucleotide sequences exhibit variability in their sensitivity to S1. The sequence of oligonucleotide #30 (SEQ ID NO:40) is:

5' -CGCGGCTGGCGCTTACTTCTGCATTGCTCAAAGAACTTCTAAGTTCGATAGCTTCCAAG -3'

This 60 bp oligonucleotide contains a 10 bp non-homologous sequence domain at the 3'-end so that, after S1 digestion, the protected oligonucleotide fragment (approximately 50 bp) can be distinguished from non-hybridized oligonucleotide probe.

The 5'-end of each oligonucleotide was labeled with ^{32}P using T4 polynucleotide kinase and [γ - ^{32}P]dATP. The reaction conditions were as follows: 200 ng oligonucleotide, 1 μl (10,000 units/ml) polynucleotide kinase (NEB), 1.0 mCi [γ - ^{32}P]dATP (3000 Ci/nmole; Amersham PB15068), 1X kinase buffer (Maniatis et al., *supra*), and incubation at 37°C for 45 minutes. Unincorporated nucleotide was removed by gel-filtration (Sephadex G-50). The specific activity of each probe was: oligonucleotide #29, 6.04×10^8 cpm/ μg ; oligonucleotide #30, 5.72×10^8 cpm/ μg .

RNA was extracted from mouse brain and HeLa cell pellets using a procedure described in *Basic Methods in Molecular Biology* (Davis et al., 1986, Elsevier, New York, Amsterdam, and London; pp. 130-135).

Total RNA, 50 μg /sample, was mixed with 1×10^6 cpm of each ^{32}P -labelled oligonucleotide (oligonucleotide #29 and oligonucleotide #30) and then dried in vacuum. The RNA/oligonucleotide pellet was resuspended in 20 μl of Hybridization buffer (1 mM EDTA, 0.4M NaCl, 50% formamide, and 40 mM Pipes pH 6.4). Hybridization was performed in a Perkin Elmer Cetus DNA Temperature Cycler (model #PCR-10000). Samples were incubated at 90°C for 10 minutes and then at 70°C for 20 minutes. The temperature was then lowered 1°C every 18 minutes until the temperature reached 30°C. The reaction was terminated by placing samples on ice. S1 nuclease digestion was initiated by addition of 300 μl of S1 reaction buffer (0.2 M NaCl, 5 mM ZnCl_2 , 30 mM sodium acetate pH 4.5, and 400 units S1) and samples were incubated at 20°C for 2 hours. S1 reaction was terminated by adding EDTA to a final concentration of 25 mM. Samples were extracted with equal volumes of phenol and then phenol/chloroform/isoamylalcohol (24/24/1). The oligonucleotides in each sample were precipitated at -70°C for 1 hour by addition of 10 μg tRNA, 175 μl of 7.5M NH_4 -acetate, and 875 μl of absolute ethanol. The oligonucleotides were resuspended in 10 μl of 10 mM Tris and 1 mM EDTA, pH 7.8. Samples were denatured by addition of 10 μl of 2X Sequencing loading Buffer (from USB) and incubation at 90°C for 3 minutes. Samples were then transferred to ice and then loaded onto a 10% denaturing polyacrylamide gel (1X TBE and 7M urea) that had been prerun for 20 minutes at 1600V, constant voltage. The samples were electrophoresed at 1600 V for approximately one hour. The gel was dried and the migration of the oligonucleotides was detected by autoradiography using Kodak X-ray film.

Figure 28 demonstrates that transgenic lines AE301, AE101, FE801, FE403, ED1001, ED801, and DH106 express human APP RNA in brain (i.e., have an approximately 70 bp-protected fragment after S1 digestion). The intensity of the approximately 70 bp band of the protected fragment in these samples was greater than the background observed in control mouse brain RNA (lane 3). The level of human-specific expression, however, is low compared to the endogenous mouse APP expression level. For size markers: gel lane 1 contains oligonucleotides 29 and 30 (9.7×10^2 and 6.1×10^2 cpm respectively) and lane 2 contains a 1 bp DNA sequencing ladder. Both oligonucleotides 29 and 30 were annealed to 50 μg of brain RNAs and samples were digested with S1 nuclease as described below. The gel contains the following RNA samples: lane 3, mouse normal brain; lane 4, HeLa cell; lane 5, AE301 brain; lane 6, AE302 brain; lane 7, AE601 brain; lane 8, AE101 brain; lane 9, FE801 brain; lane 10, FE403 brain; lane 11, ED1001 brain; lane 12, ED106 brain; lane 13, ED801 brain; lane 14, JE711 brain; lane 15, JE1005 brain; lane 16, DH106 brain; lane 17, GE107 brain.

Figure 27 demonstrates that transgenic lines IE504, IE801, IE301, IE606, IE206, DM101, DM405,

DM406, and DM606 express human APP RNA in brain (i.e., have an approximately 70 bp-protected fragment after S1 digestion). The intensity of the approximately 70 bp band of the protected fragment in these samples was significantly greater than the background observed in control mouse brain RNA (lane 3). The level of human-specific expression, however, is low compared to the endogenous mouse APP expression level. For size markers: gel lane 1 contains oligonucleotides 29 and 30 (9.7×10^2 and 6.1×10^2 cpm respectively) and lane 2 contains a 1 bp DNA sequencing ladder. Both oligonucleotides 29 and 30 were annealed to 50 μ g of brain RNAs and samples were digested with S1 nuclease as described below. The gel contains the following RNA samples: lane 3, normal mouse brain; lane 4, HeLa cell; lane 5, IE602 brain; lane 6, IE504 brain; lane 7, IE801 brain; lane 8, IE301 brain; lane 9, IE205 brain; lane 10, IE606 brain; lane 11, IE206 brain; lane 12, IE505 brain; lane 13, IE803 brain; lane 14, DM101 brain; lane 15, DM309 brain; lane 16, DM405 brain; lane 17, DM406 brain; lane 18, DM606 brain.

B. Riboprobe Analysis

RNase A and RNase T1 digest single-stranded RNA but not double-stranded RNA species. Therefore, specific riboprobes (32 P-labelled anti-sense RNA) that hybridize with complementary mRNA sequences, are protected from digestion by a cocktail of RNase A and RNase T1 and can be identified by denaturing polyacrylamide gel electrophoresis (PAGE). The Bluescript M13 phagemid (Stratagene, San Diego, CA) contains a multiple restriction enzyme polylinker flanked by promoters for T7 and T3 RNA polymerase. The promoters are positioned in opposite orientations and can be utilized to transcribe 32 P-labelled anti-sense RNA probes specific to any sequence inserted into the polylinker region. Clone pMTI-2371 (see Example 16, part B, and Figure 41) contains the human APP sequences encoding the MC-100 gene product (gene product V, Figure 4b; see also Figure 12 and Example 9, part A, section 3) inserted into Bluescript KS+. A riboprobe which specifically hybridizes to human APP mRNA was generated using T7 RNA polymerase and linearized pMTI-2371 (phagemid digested with HincII) as template. The riboprobe was -408 bp in length and the portion complementary to human APP was -373 bp. Therefore, RNase A/RNase T1 digestion of the riboprobe, which has been hybridized with human APP mRNA, would generate an -373 bp-protected fragment. RNase A/RNase T1 digestion of riboprobe, which has been hybridized with mouse APP mRNA, would result in numerous fragments which are considerably smaller than 373 bp. The template was prepared and the 32 P-labelled riboprobe was generated (using 60 μ Ci of 32 P-rUTP [sp. act.: 800 mCi/mmol] obtained from Amersham (Arlington Heights, IL). RNA was prepared from the HeLa cell line, the brain of a normal mouse, and the brains of individuals from the following lines of transgenic mice: AE101, AE301, CA507, FA201, FE1001, FE403, IE801, JA407, JA1301, SA110, SA602, and SA706 using methods described in Example 13, part A. RNA samples (20 μ g) were precipitated with 1/10 volume, 3 M sodium acetate pH 5.2, and 2.5 volumes ethanol. Each RNA sample was resuspended in 20 μ l of 1X hybridization buffer (80% formamide, 40 mM PIPES pH 6.4, 0.4 M NaCl, and 1 mM EDTA) and 10 μ l of riboprobe (2×10^5 cpm in 1X hybridization buffer). Samples were incubated at 85°C for 10 minutes and then incubated at 45°C overnight. The RNA samples were digested by addition of 350 μ l of ribonuclease buffer (10 mM Tris pH 7.5, 300 mM NaCl, and 5 mM EDTA) with 40 μ g/ml RNase A and 2 μ g/ml RNase T1 and incubation at 30°C for 60 minutes. To each sample was added 20 μ l of 10% SDS and 2.5 μ l of 20 mg/ml proteinase K. Samples were incubated at 37°C for 15 minutes and then extracted with phenol/isoamylalcohol/chloroform. The samples were precipitated by addition of 10 μ g of tRNA and 1 ml of ethanol. Samples were resuspended and electrophoresed on a denaturing polyacrylamide/urea gel as described in Example 13, part A. The gel represented in Figure 46 contains the following RNA samples: lane 1, HeLa cell RNA; lane 2, normal mouse; lane 3, AE301; lane 4, AE301; lane 5, AE101; lane 6, CA507; lane 7, FA201; lane 8, FE1001; lane 9, FE403; lane 10, IE801; lane 11, JA407; lane 12, JA1301; lane 13, SA110; lane 14, SA602; lane 15, SA706; lane 16, blank; lane 17, riboprobe (undigested); and lane 18, riboprobe (undigested). The protected riboprobe fragments were detected by autoradiography as shown in Figure 46. The experiment demonstrated that the following transgenic mouse lines express human APP RNA: AE101, AE301, CA507, FE1001, IE801, JA407, JA1301, SA602, and SA706 (see Table III).

EXAMPLE 14

Expression of Human APP and APP Derivatives in Transgenic Mice

A. Expression of APP-751

Transgenic mouse line IE801 (see Table III) expresses human APP-751 protein in the brain (Figure 28a)

and 28b). Human APP-751 expression (Figure 28b) was detected in protein extracts of transgenic mouse brain by Western-blot analysis using the human-specific monoclonal antibody (mAb), mAb 56-1 (see Example 17). Western-blot analysis of protein extracts from transgenic mouse brains were also stained using mAb 22C-11 which reacts with APP-695, APP-751 and APP-770 from both human and mouse (Figure 28a). The monoclonal antibody, mAb 22C-11, was a gift from Dr. Beyruether (Weidemann et al., 1989, Cell 57: 115-126).

Figure 28a contains the following samples: lane 1, low molecular weight protein markers; lane 2, DH106 brain lysate; lane 3, DM606 brain lysate; lane 4, JE711 brain lysate; lane 5, IE508 brain lysate; lane 6, IE801 brain lysate; lane 7, IE301 brain lysate; lane 8, normal mouse (ICR strain) brain lysate; lane 9, media from cell line, cMTI-53; and lane 10, high molecular weight protein markers.

Figure 28b contains the following samples: lane 1, high molecular weight protein markers; lane 2, cell line cMTI-53; lane 3, normal mouse (ICR) brain lysate; lane 4, IE301 brain lysate; lane 5, IE801 brain lysate; lane 6, IE508 brain lysate; lane 7, JE711 brain lysate; lane 8, DM606 brain lysate; lane 9, DH106 brain lysate; and lane 10, low molecular weight protein markers.

Figure 28a demonstrates that each brain extract contains approximately equal amounts of APP protein and that APP-695 is the predominant form of APP in mouse brain extracts. The extracellular forms of APP-695 and APP-751 (or 770) have apparent molecular weights of ~93-105 kDa and ~112-125 kDa respectively (Weidemann et al., 1989, supra and Palmert et al., 1989, Proc. Natl. Acad. Sci. USA 86: 6338-6342). Protein from the culture media of a mouse cell line (line cMTI-53; see Example 16) which secretes human APP-751 was included as control (Figure 28b, lane 2). We could not determine whether transgenic mouse lines DH101 or DH106 expressed human APP-695 because of the cross-reactivity of mAb 22C-11 for mouse and human APP-695.

Figure 28b demonstrates that transgenic mouse line IE801 (lane 5) expresses a protein which reacts with mAb 56-1 and has a gel migration mobility equal to that of APP-751 secreted by the cell line cMTI-53 (lane 2). A non-transgenic mouse (lane 3) or transgenic mice carrying minigenes encoding human APP-695 (DH101 and DH106) do not exhibit immunostaining of this protein. Transgenic mouse line IE508 also expressed cross-reactive proteins species. However, the migration of the proteins does not correspond to human APP-751. It is possible that human APP-751 is anomalously expressed or metabolized in the IE301 line and no APP-770 expression was observed in the JE711 line.

Protein was extracted from the brain of a non-transgenic control mouse (ICR strain) and the brains of transgenic animals from the following lines: DH106, DM606, JE711, IE508, and IE301. Whole brains were dissected from the animals and weighed to estimate tissue volume. Two volumes of lysis buffer (0.2M NaCl, 1% Triton X-100, 2 mM PMSF (Sigma #P-7626), 1 mM DFP, 1X protease inhibitor solution, 10 mM Tris pH 8.0) was added to each brain. Protease inhibitor solution, 100X, consisted of: 1 mg/ml leupeptin (Sigma #L-2884), 1 mg/ml pepstatin-A (Sigma #P-4265), 10 TIU/ml aprotinin (Sigma 3A-6012), 0.1 mM EDTA, and 0.2M Tris pH 8.0. Brain tissue was then homogenized for ~1 minute with a Polytron homogenizer (model CH6010). Each sample was centrifuged at 10,000 x g at 4 °C for 30 minutes and the supernatant (lipid layer removed), or "brain lysate," was stored at -70 °C. Protein in culture media for cell line cMTI-53 was concentrated by acid precipitation. Approximately 1.5 ml of culture media, ice cold, was harvested and a 1.5 ml aliquot of 25% trichloroacetic acid (TCA), ice cold, was added. Samples were centrifuged at 15,000 x g for 10 minutes at room temperature. The protein pellets were washed three times with 100% acetone and then centrifuged after each wash at 15,000 x g for 10 minutes at room temperature. The pellets were dried in a vacuum for ~20 seconds, resuspended in 100 µl of NRSB buffer (2% SDS, 5% betamercaptoethanol, 5% loading dye, 10% glycerol, 0.125 M Tris pH 8.8) and boiled for 5 minutes.

The "brain lysate" proteins and cMTI-53 cell supernatants were fractionated by polyacrylamide gel electrophoresis (10% running gel and 4% stacking gel) and transferred to Immobilon-P membrane by the technique of electroblotting using a Biorad Mini-Protean II apparatus and using procedures recommended by the manufacturer. Prior to electrophoresis, 10 µl human APP-751 control cell supernatant (cell line cMTI-53), 1 µl of control mouse brain lysate, and 2 µl aliquots of transgenic mouse brain lysates were denatured by addition of 1X NRSB and boiling for 5 minutes. Each gel also included pre-stained high and low molecular weight standards (BRL catalog #6041LA and #6040SA, respectively).

Human and mouse APP proteins, transferred from the polyacrylamide gels onto Immobilon-P membrane, were detected by Western-blot staining. Mouse and human APP-695, APP-751 and APP-770 proteins were detected using mAb 22C-11. Human APP-751 was detected using mAb 56-1; this antibody does not recognize mouse APP-751. After protein transfer, the Immobilon membranes (12 x 12 cm) were incubated with 50 ml 1X blocking buffer (0.15M NaCl, 5% non-fat dry milk, and 10 mM Tris pH 8.0) for one hour at room temperature. Membranes were then stained with 10 ml of "first" antibody solution (22C-11: 1:10,000 dilution of mAb stock into blocking; or mAb 56-1: 1:100 dilution of mAb stock into blocking buffer)

for 2 hours at room temperature. Membranes are next washed with blocking buffer and then stained with 15 ml of "second" antibody solution [goat anti-mouse IgG conjugated with alkaline phosphatase (Promega): 1:7500 dilution of antibody into blocking buffer] for 30 minutes at room temperature. Membranes are then washed with blocking buffer and then with AP buffer (0.1M NaCl, 5 mM MgCl₂, 0.1M Tris pH 9.5).
 5 Membranes are next stained with "AP substrate" solution (15 ml AP buffer, 99 μ l NBT stock solution, and 49 μ l BCIP stock solution) for one hour at room temperature. NBT stock solution consists of 50 mg/ml nitro blue tetrazolium (Sigma #N-6876) in 70% dimethylformamide and BCIP stock solution consists of 50 mg/ml 5-bromo-4-chloro-3-indolyl phosphate in 100% dimethylformamide. The AP staining reaction was determined by washing membranes in deionized water.

10

B. Expression of A4 APP Peptide

Transgenic mouse line AE301 (see Table III) carries minigene pMTI-2318 (gene product VIII, Figure 4b), which encodes the 42 amino acid A4 peptide of APP (see Example 7 above). This line of transgenic
 15 mice has been shown to express APP RNA in brain (see Example 13 above). In further studies, it was shown that AE301 transgenic mice exhibit A4 aggregates in the hippocampus region of the brain. This transgenic line can be used to examine the neurotoxicity of the A4 peptide in brain tissue. In addition, the A4 aggregates present in the transgenic mice may represent an early stage of senile plaque formation. These transgenic mice can serve, therefore, as a model for early pathological events occurring in patients
 20 affected with AD. Aggregation of A4 peptide was demonstrated by several methods, including immunocytochemical analysis and electron microscopic (EM) analysis.

1. Immunocytochemical Analysis of A4 Aggregates

25 Rabbit polyclonal antibodies (pAb) 90-25, 90-28 and 90-29, used for the immunocytochemical analysis, were generated by standard methods. Subcutaneous injections of the A4 peptide (amino acid residues 1 to 28 for pAb 90-25, and amino acids 1 to 42 for pAbs 90-28 and 90-29) were administered to rabbits using Freund's adjuvant. Rabbit sera were screened for immunoreactivity to the A4 peptide and several, including pAb 90-25, 90-28 and 90-29, tested positive. These positive antibodies were further characterized by
 30 reaction with pathological human brain tissue from a patient with AD. The pAb 90-25, 90-28 and 90-29 immunostain A4 amyloid plaques (senile plaques) found in the pathological tissues.

Once the specificity of pAb 90-25, 90-28 and 90-29 with A4 peptide had been established, these antibodies were used to immunostain cross-sections of brain tissue from mice. Light microscopic immunochemistry was performed using paraffin tissue sections, according to the method of Trapp et al., 1983,
 35 J. Neurochem. 40: 47-54. The results showed immunostaining of specific areas of the hippocampus region of the brain from an AE301 transgenic mouse as shown in Figures 34, 35, and 36. The transgenic mouse, designated AE301+207 (F1), used for this immunocytochemical analysis was a transgenic progeny of a mating between AE301(F0), the founder mouse, and a non-transgenic female (ICR200). Transgenic progeny of this mating were identified by PCR analysis as described in Example 11 above.

40 Figure 34 illustrates a cross-section of brain from mouse AE301+207(F1) immunostained with pAb 90-29. A4 immunoreactive regions can be observed as dark-brown areas, are punctate in nature, and appear in clusters in the hippocampus (Figure 34, representative immunostained clusters are highlighted with arrows). Figure 35 is a higher magnification of the hippocampal region of mouse AE301+207(F1) brain tissue stained with pAb 90-29 (representative immunoreactive regions are highlighted with arrows). Similar
 45 immunostaining in the hippocampus of AE301+207(F1) brain tissue can be observed with a second A4 immunoreactive antibody, pAb 90-28 (Figure 36, representative immunoreactive regions are highlighted with arrows). A third A4 immunoreactive antibody, pAb 90-25, also showed similar immunostaining.

This immunostaining was specific to the AE301 transgenic line because an age-matched mouse, designated FE803+105(F1), from transgenic line FE803 which carries pMTI-2321 (see Example 6 and
 50 Table II) does not exhibit immunostaining with pAb 90-29 in the hippocampus or in other regions of the cross-section of brain (Figure 37).

2. Electron Microscopic Analysis

65 Transmission electron microscopic analysis of thin sections of fixed and stained brain tissue was performed according to the method of Trapp et al., 1982, J. Neurosci. 2: 986-993. The transgenic mouse used for this electron microscopic analysis was designated AE301+201(F2) and is the progeny of a mating between AE301+210(F1) and AE301+207(F1); AE301+210(F1) and AE301+207(F1) are progeny of a

mating between AE301+(F0) and a non-transgenic female (ICR200). These transgenic progeny were identified by PCR analysis as described in Example 11 above.

The results showed electron-dense aggregates in specific areas of the hippocampal region of the brain from this transgenic mouse. The electron-dense aggregates were found in the same brain regions which exhibited immunochemical staining with pAbs 90-25, 90-28 and 90-29. The aggregates appear to be located within the intracellular space of neuron dendrites. Figures 38a and 38b illustrate electron-dense aggregates in thin sections of hippocampal brain tissue isolated from transgenic mouse AE301+201(F2). The borders of the electron-dense aggregates are highlighted with arrows.

That electron-dense regions are aggregates of the A4 peptide was demonstrated since immunoreactivity with pAb 90-29 co-localized with the electron-dense aggregates (Figure 39). This co-localization was shown using EM immunocytochemistry of ultrathin cryosections as performed according to the method of Trapp et al., 1989, J. Cell Biol. 109: 2417-2426. The immunoreactivity of pAb 90-29 was detected in the electron micrographs using immunogold particles. Immunogold particles appear as discrete dots of uniform size in the electron micrographs. Representative regions, where gold particles co-localize with the electron-dense aggregates, are indicated by arrows.

EXAMPLE 15

Expression of Human APP Gene Products in COS Cell Transfections

DNA transfections of COS cells (Gluzman, 1981, Cell 23: 175-182) demonstrate that pMT1-2360, pMT1-2362, pMT1-2369, and pMT1-46 express and secrete human APP-695 as described below and shown in Figure 29.

For DNA transfections, 60 mm culture dishes were seeded with approximately $2-5 \times 10^5$ COS cells/dish (~50% confluency) in 3 ml DMEM and 10% fetal calf serum. Cells were cultured overnight at 37°C in a 6% CO₂ atmosphere. Cells were washed with PBS (no Ca⁺⁺ or Mg⁺⁺) and then 2 ml of DMEM plus 10% NuSerum (catalog #50000) was added to each plate. Then 2 µl of 1000X chloroquine stock solution (0.1 M chloroquine, Sigma no. C-6628), 32 µl of DEAE dextran sulfate stock solution (25 mg/ml DEAE dextran sulfate, Sigma no. D-9885), and 4 µg of DNA was added to each plate. Cells were incubated for 3.5 hours at 37°C in a 6% CO₂ atmosphere. Cells washed with PBS and then "shocked" with 2 ml of 10% DMSO in PBS and incubated at 37°C in a 6% CO₂ atmosphere with DMEM plus 10% fetal calf serum for 48 hours then washed 3 times with PBS and cells were further incubated at 37°C in a 6% CO₂ atmosphere with "Cutter" media for an additional 24 hours.

Protein in culture media from COS cells, transfected COS cells, and human neuroglioma cell line H4 (A.T.T.C. no. HTB148) was concentrated by acid precipitation. Approximately 3 ml of each culture media, ice cold, was harvested and a 3 ml aliquot of 25% trichloroacetic acid (TCA), ice cold, was added. Samples were centrifuged at 20,000 x g for 30 minutes at 4°C. The protein pellets were washed three times with 100% acetone and then centrifuged after each wash at 10,000 x g for 15 minutes at 4°C. The pellets were dried in a vacuum for ~20 seconds, resuspended in 10 µl of NRBS buffer (2% SDS, 10% betamercaptoethanol, 5% loading dye, 10% glycerol, 0.125 M Tris pH 6.8), and boiled for 5 minutes.

Cell supernatant protein was fractionated by polyacrylamide gel electrophoresis (8% running gel and 4% stacking gel) and transferred to Immobilon-P membrane by the technique of electroblotting using a Biorad Mini-Protean II apparatus and using procedures recommended by the manufacturer. Human and mouse APP proteins, transferred from the polyacrylamide gels into Immobilon-P membranes, were detected by Western-blot staining as described in Example 14. Mouse and human APP-695, APP-751 and APP-770 proteins were detected using monoclonal antibody (mAb) 22C-11.

APP protein secreted into media from various transfected cell cultures was detected in Western-blots using mAb 22C-11. COS cells express predominately APP-751 (and/or 770) and a smaller amount of APP-695 (Figure 29, lane 8). The secreted forms of APP-695 and APP-751 (or 770) have apparent molecular weights of ~93-105 kDa and ~112-125 kDa, respectively (Weidemann et al., 1989, supra, and Palmert et al., 1989, supra). Human cerebral spinal fluid (CSF) contains predominately APP-695 (Palmert et al., 1989, supra) and is included on the Western-blot as a control for APP-695 expression (lane 9, Figure 29). Several DNA transfections (pMT1-2360, lane 7; pMT1-2362, lane 6; pMT1-2369, lane 5; and pMT1-46, lane 4) exhibit significant increases in APP-695 immunostaining relative to APP-751(770) immunostaining (Figure 29). Therefore, these constructs express human APP-695 in COS cells. These APP-695 encoding minigenes are used as a "template" for construction of minigenes encoding alternate or mutant forms of APP. Because the parent APP-695 constructs express protein, it is highly likely that the other constructs also will express their proteins.

EXAMPLE 16**Expression of APPs in Mammalian Cell Lines**

- 5 Stable cell lines expressing the 695, 751 and 770 forms of APP, as well as a mutated form of APP MC-100, were constructed as follows using bovine papilloma virus- (BPV) based vectors.

A. Cell Lines for APP-695, APP-751 and APP-770

- 10 Plasmid pMTI-4 described in Example 6 was mutagenized at the 5'-end of the APP-695 cDNA to create a new *Sall* restriction site. In addition, during the mutagenesis procedure, the bases flanking the initiation codon, AUG, were altered to conform to the optimum sequence for translation initiation described by Kozak (Kozak, 1989, *Cell Biol.* 108: 229-241). The oligonucleotide primer used in the mutagenesis and map of the resulting vector, pMTI-38, are shown in Figure 30a.

- 15 Plasmid pMTI-41 was constructed by deleting the unique *KpnI* site in Bluescript KS (Stratagene; parent vector for pMTI-4). Bluescript KS was digested with *KpnI* and the overhangs were digested with mung bean nuclease by standard methods. The digested DNA was treated with ligase to circularize the vector and pMTI-41, lacking the *KpnI* site was isolated.

- 20 The *XbaI* - *HindIII* fragment from pMTI-38, containing the APP-695 cDNA, was introduced into *XbaI* - *HindIII* digested pMTI-41 as shown in Figure 30 to obtain pMTI-42 which has only one *KpnI* site within the APP cDNA. pMTI-43 and pMTI-44 containing respectively the 751 and 770 forms of APP were constructed by replacing the *KpnI* - *BglII* fragment in pMTI-42 with the corresponding fragments from pFC4-751 and pFC4-770 described in Example 3.

- 25 *Sall* fragments containing the APP regions in pMTI-42, pMTI-43 and pMTI-44 were introduced into the *XhoI* site of the BPV vector pMTI-52, placing them under the control of the mouse metallothionein promoter illustrated in Figure 31. As shown in Figure 31, pMTI-52 contains the *colE1* replicon, the ampicillin resistance gene, the mouse metallothionein promoter a unique cloning site for cDNAs followed directly by the polyadenylation signal of SV40. Specifically, pMTI-52 contains *BamHI* and *XhoI* cloning sites for introduction of cDNAs of interest. In addition, the pMTI-52 vector contains the entire 8 kb genome of BPV.
- 30 The presence of BPV sequences allows the vector to replicate as a multicopy episome in mouse C127 and NIH3T3 cells resulting in stably transformed cell lines. The plasmid pMTI-52 was constructed by ligating the -237 bp *BamHI*-*BclI* fragment (containing the viral polyadenylation signals) from SV40 viral DNA into the unique *BamHI* site of pMTI-32. Diagnostic restriction digestion of pMTI-52 with *BamHI* and *PvuII* gave the following DNA restriction fragments: -11.5 kb, -0.55 kb, and -0.25 kb. pMTI-32 was generated by ligating
- 35 an -1.8 kb *BamHI*-*BglII* restriction fragment from pMTI-29 (this DNA fragment contains the mouse metallothionein gene promoter, which can be obtained from alternative sources, for example, the -1.9 kb *EcoRI*-*BglII* fragment from plasmid pJYMMT(L) described in Example 9 also contains an analogous promoter fragment) into the unique *BamHI* restriction site of plasmid BPV-240.7. Plasmid BPV-240.7 was used as a source of the entire BPV genome and is a variant of the BPV vectors described and prepared by
- 40 Howley et al., 1983, in *Methods of Enzymology*, Volume 101, Wu et al., eds., Academic Press, NY, pp. 387-402. Alternative sources of the -8 kb BPV genome may be used, in particular, any number of the BPV vectors described by Howley et al., *supra*, with minor changes in restriction enzyme cleavage sites, can serve as a source of the BPV genome in place of BPV 240.7 in the construction of pMTI-52. Diagnostic restriction digestion of pMTI-32 with *BamHI* and *HindIII* gave the following DNA restriction fragments: 8.0 kb and 4.1 kb. pMTI-29 was generated by inserting *BglII*, *XbaI*, and *Sall* restriction sites (using a synthetic DNA linker) into the unique *EcoRI* restriction site of plasmid pMVBneo. Plasmid pMVBneo has been described by
- 45 Pavlakis et al., 1987, in *Gene Transfer Vectors*, Miller and Calos, eds., Cold Spring Harbor Laboratory Press, Cold Spring Harbor, NY, pp. 29-58, and was used as a source of the mouse metallothionein gene promoter. Alternative sources of this promoter may be used, for example, plasmid pJYMMT(L) (see
- 50 Example 9). Diagnostic restriction digestions of pMTI-29 with either *Sall* or *XbaI* yielded a single 6.7 kb DNA restriction fragment. The BPV vectors pMTI-53, pMTI-57 and pMTI-58 contain the 695, 751 and 770 forms of APP, respectively.

- Each BPV vector, pMTI-53, pMTI-57 or pMTI-58 was transfected into mouse C127I cells (a variant of C127 obtained from Dr. D. DiMaio, Yale University) which are permissive for the high-copy-number,
- 55 episomal replication of BPV vectors (Howley et al., 1983, *Methods in Enzymol.* 101 387-403). Vectors were introduced into cells by calcium phosphate precipitation and the transformed foci were isolated as described (Howley et al., 1983, *supra*). Alternatively, in some cases, the vectors were co-transfected (Howley et al., 1983, *supra*) with pSV2neo (Southern and Berg, 1982, *J. Mol. Appl. Gen.* 1: 327-341) which

is capable of conferring resistance to the antibiotic G418. BPV vector DNAs were mixed with pSV2neo DNA at 5- to 10-fold molar excess (BPV vectors in excess) and transfected into C1271 cells by calcium phosphate precipitation. Colonies resistant to G418 were isolated. The molar excess of BPV DNA over pSV2neo DNA ensured that almost every G418 resistant colony contained the cotransfected BPV vector.

5 Transfection of APP cDNAs into various cell types has shown that the amino-terminal region of APP, including the Kunitz domain, is released into the medium (Weidemann et al., 1989, Cell 57: 115-126 and Palmert et al., 1989, *supra*). Therefore, serum-free, 24-hour supernatants from transformed foci and the G418 resistant colonies were screened for the appropriate form of APP by Western-blot analysis. Proteins in 1.5 ml of supernatants from semi-confluent to confluent 25 square cm flasks were concentrated
10 approximately 15-fold by precipitation with trichloroacetic acid (TCA) prior to loading onto polyacrylamide gels. APP bands were visualized using the mouse monoclonal antibody 22C11 (see Example 14). Clones producing high levels of the appropriate APP form were expanded and propagated in culture. Supernatants from these cell lines, cMTI-53, cMTI-57 and cMTI-58 provided standards for the three forms of human APP.

15 B. Cell Lines for MC-100

Further transfections of mouse C1271 cells were performed using the plasmid vector pMTI-70 (~12.9 kb, Figure 40). This plasmid was constructed by cloning an ~615 bp XhoI-PvuII fragment from the vector pMTI-2371 (Figure 41) into the BPV vector pMTI-52. pMTI-52 was first digested with BamHI and then a blunt-end
20 was generated using Klenow. The vector was then digested with XhoI and the large restriction fragment was gel-purified and ligated with the ~615 bp XhoI-PvuII fragment from the vector pMTI-2371 to generate pMTI-70. Diagnostic digestion of pMTI-70 with HindIII revealed an ~3.6 kb and an ~9.3 kb restriction fragment. The pMTI-2371 plasmid was derived by cloning the ~707 bp BamHI-SpeI fragment from pMTI-2337 between the BamHI and the XbaI sites of the Bluescript KS+ vector (see Example 6). Construction of
25 plasmid pMTI-2337 is described in Example 9 (part A, section 3).

Plasmid pMTI-70 contains the sequences derived from pMTI-2337 which encode the mutation designated MC-100 (gene product V, Figure 4b, see also Figure 12). The fragment obtained from pMTI-2337 (with pMTI-2371 as an intermediate) used for the construction of pMTI-70 encodes the C-terminal segment
30 common to the three forms of APP (695, 751, 770), including the A4 region, preceded by the secretion signal (i.e., signal peptide) of the APPs. Thus, translation of this APP minigene is expected to result in the incorporation of the APP C-terminus into the membrane of the cell transfected with this minigene.

Plasmid pMTI-70 was transfected into mouse C127 cells as described above and colonies resistant to G418 were isolated to generate stable transfectant cell lines which included lines: cMTI70-A2, cMTI70-A3, cMTI70-A6, cMTI70-B1, cMTI70-B2, and cMTI70-B3. Cell lysates of such resistant clones were analyzed by
35 Western-blotting using a rabbit polyclonal antibody (pAb) SG369. The pAb SG369 (described in Buxbaum et al., 1990, Proc. Natl. Acad. Sci. USA 87: 6003-6006 was raised by immunization of a rabbit with a synthetic peptide corresponding to the C-terminus of human APP-695 using standard immunization procedures and techniques (as described in Buxbaum et al., 1990, *supra*). The synthetic peptide consisted of APP amino acid residues 645-694, wherein the numbering of amino acids corresponds to those of human
40 APP-695 as described in Kang et al., 1987, *supra*) and was prepared by the Yale Protein and Nucleic Acid Chemistry Facility (New Haven, CT). Rabbit polyclonal antibodies with similar characteristics as those of pAb SG369 have also been generated by other laboratories using various human APP-695 C-terminal peptides (Ishii et al., 1989, Neuropath. Appl. Neurobiol. 15: 135-147; Palmert et al., 1989, *supra*; and Bush et al., 1990, J. Biol. Chem. 265: 15977-15983). Figure 42 shows the results of the Western-blot analysis of
45 cell lysates of pMTI-70 transfected BPV cell lines cMTI70-B1, cMTI70-B2, and cMTI70-B3. The Western-blot shown in Figure 42 also shows the results of using cell extracts from control BPV cell transfectants which do not express MC-100. Cell cultures were grown to 100% confluency, washed with 1 mM EDTA in PBS, and extracted by boiling for 10 minutes in 1X SSB (2% SDS, 63 mM Tris pH 6.8, and 10% glycerol), 5% β -mercaptoethanol, and 5% bromophenol blue. The Western-blot analysis was performed as described
50 above. The Western-blot illustrated in Figure 42 contains the following samples: lane 1, molecular weight markers; lane 2, cMTI52-A4 cell extract; lane 3, cMTI66-B6 cell extract; lane 4, cMTI66-C5 cell extract; lane 5, cMTI69-C6 cell extract; lane 6, cMTI69-A4 cell extract; lane 7, cMTI69-A5 cell extract; lane 8, cMTI70-B1 cell extract; lane 9, cMTI70-B2 cell extract; and lane 10, cMTI70-B3 cell extract. Polyclonal antibody SG369 was used in this Western-blot analysis. BPV cell line cMTI52-A4 was transfected with pMTI-52 (BPV cloning
55 vector); BPV cell transfectant lines cMTI66-B6 and cMTI66-C5 carries BPV vector pMTI-66 which encodes the A4 peptide of human APP (gene product VIII, Figure 4b; see Example 7 above); and BPV cell transfectant lines cMTI69-C6, cMTI69-A4, and cMTI69-A5 carry the BPV vector pMTI-69 which encodes the Sp-A4 peptide of human APP (gene product VII, Figure 4b; see Example 9A, section 4). A major

immunoreactive band between 14 kD and 21 kD representing the product of the APP minigene is seen. Also present are immunoreactive bands of higher molecular weights consistent with their being aggregation products of the primary translation product (indicated by arrows).

The transcription of the APP minigene in pMTI-70 is under the control of the mouse metallothioneine promoter which is inducible by heavy metals such as cadmium (Hämer, D.H. and Welling, M.J., 1982, J. Mol. Appl. Genet. 1: 273-288). Induction of cell lines cMTI70-A2, cMTI70-A3, cMTI70-A6, cMTI70-B1, cMTI70-B2, and cMTI70-B3 with cadmium would be expected to result in increases in mRNA levels and resultant increases in MC-100 protein levels as shown in the Western-blot illustrated in Figure 43. Cell cultures were grown to 100% confluency, washed with PBS, incubated with DMEM with 5 µg/ml cadmium chloride at 37 °C in 5% CO₂ for 16 hours, and then extracted by boiling for 10 minutes in 1X SSB (2% SDS, 63 mM Tris pH 6.8, and 10% glycerol), 5% β-mercaptoethanol, and 5% bromophenol blue. The Western-blot analysis was performed as described above. The Western-blot illustrated in Figure 43 contains the following samples: lane 1, cMTI63-B1 cell extract; lane 2, cMTI63-C2 cell extract; lane 3, molecular weight markers; lane 4, cMTI53-A1 cell extract; lane 5, cMTI70-A2 cell extract; lane 6, cMTI70-A3 cell extract; lane 7, cMTI70-A6 cell extract; lane 8, cMTI70-B1 cell extract; lane 9, cMTI70-B2 cell extract; and lane 10, cMTI70-B3 cell extract. BPV cell transfectant lines cMTI63-B1 and cMTI63-C2 carry BPV vector pMTI-63 which encodes the human APP-695 with a C-terminal addition of the Chlamydia epitope (see Example 8) and BPV cell transfectant line cMTI53-A1 which carries BPV vector pMTI-53 which encodes human APP-695. The higher molecular weight bands corresponding to the aggregated molecules increase in intensity upon cadmium induction (as indicated by arrows). This observation is consistent with the expectation that aggregation is a concentration dependent phenomenon.

The pMTI-70 transfected and G418 selected cells were also analyzed by immunofluorescence of stained cells and immunoprecipitation of cell lysates using the SG369 antibody. The results demonstrated the accumulation of the MC-100 fragment in the transfected cells. Figures 44a and 44b show immunofluorescence results of two representative fields where a limited number of cells in the population of cMTI70-A6 cells show intense fluorescence. Transfected cell line cMTI-53 (which expresses human APP 695) does not exhibit these immunofluorescent cells (Figure 44c). Cultures of cell lines cMTI70-A6 (transfected with pMTI-70, see above) and cMTI53-A1 (express human APP 695) were grown to 70% confluency using standard culture conditions, the cells were washed with PBS, and incubated for 16 hours with DMEM supplemented with 5 µg/ml cadmium chloride. The induced cMTI53-A1 and cMTI70-A6 cells were then washed twice with PBS, and fixed using 4% paraformaldehyde in PBS at room temperature for 10 minutes. The cells were permeabilized with 0.2% Triton X-100, 10 mM Tris pH 8.0, 0.2 mM EDTA at room temperature for 5 minutes. The fixed and permeabilized cells were then incubated with affinity purified pAb SG369 (1:200 dilution of stock) in PBS and 3% bovine serum albumin (BSA) at room temperature for 60 minutes. The cells were washed 5 times with 3% BSA in PBS and then incubated with goat anti-rabbit IgG conjugated with rhodamine (obtained from Boehringer Mannheim) in PBS and 3% BSA at room temperature for 30 minutes. The cells were then washed 5 times with 3% BSA in PBS. The fluorescence of the cells was observed on mounted slides using a Zeiss IM fluorescent microscope. As shown in Figure 44, the staining is punctate in nature and localized at the cell periphery, away from the site of synthesis in the endoplasmic reticulum (ER) and Golgi. This staining pattern suggests highly localized concentrations of MC-100 protein. Upon continued passage of the C127/pMTI-70 transfected cells, it has been observed that fluorescent cells are lost from the population with continued passage. This suggests that production of MC-100 may confer a selective disadvantage to these cells.

Figure 45 shows a Western-blot of immunoprecipitated MC-100 from extracts from the cell line cMTI70-A6 (transfected with pMTI-70, see above). The results indicate that the MC-100 aggregates, observed in Figures 42 and 43, can be immunoprecipitated from cell lysates (Figure 45, lane 6). Cultures of cell line cMTI70-A6 (transfected with pMTI-70, see above) were grown to 100% confluency using standard culture conditions, the cells were washed with PBS, and incubated for 16 hours with DMEM supplemented with 5 µg/ml cadmium chloride. The induced cMTI70-A6 cells were resuspended twice, washed with 1 mM EDTA in PBS, and the cells were pelleted by centrifugation (1000 x g) and resuspended in IP (lysis) buffer (100 mM Tris pH 7.4, 150 mM NaCl, 2 mM NaN₃, 1% Nonidet P-40, 0.5% sodium deoxycholate, 0.1% SDS, and 40 units/ml aprotinin). An aliquot of this cell lysate appears in Figure 45, lane 1. The cell lysate was incubated with a 1:50 dilution of affinity purified pAb SG369 for 2 hours at 4 °C. The extract was then incubated with a 1:10 dilution of protein-G Sepharose (stock, 2 mg/ml in PBS; obtained from Sigma) at 4 °C overnight with gentle agitation. The protein-G Sepharose beads were then collected by centrifugation (12,000 x g for 15 seconds at 4 °C) and an aliquot of the supernatant appears in Figure 45, lane 2. The pellet was washed 3 times with IP (lysis) buffer. An aliquot of each wash appears in Figure 45, lanes 3, 4, and 5. The proteins were solubilized, boiling for 10 minutes in 1X SSB (2% SDS, 63 mM Tris pH 6.8, and

10% glycerol), 5% β -mercaptoethanol, and 5% bromophenol blue. An aliquot of the solubilized immunoprecipitant appears in Figure 45, lane 6. The Western-blot analysis was performed as described above using the SG369 antibody.

The C1271/pMTI-70 clones thus provide a mammalian cell host/vector system in which the aggregation of a segment of APP containing the A4 region was observed. Since this reaction is a critical step in amyloid formation, this host/vector system is valuable for studying: (i) the steps in amyloid formation by studying the aggregation process *in vitro* and (ii) methods for intervention into this process by characterizing chemical and physical agents that accelerate or interfere with amyloid aggregation. In addition, the MC-100 minigene in pMTI-70 may be expressed in other cell lines including neurons to study amyloid formation in different cell lines.

EXAMPLE 17

Generation of Human APP-specific Mouse Monoclonal Antibodies, 56-1 and 56-2

Monoclonal antibodies reactive to the 56 and 75 amino acid Kunitz domain inserts of APP were generated as follows:

Immunogen: The immunogen used in the immunization of mice was the enriched pellet fraction of bacterium *E. coli* expressing the 75 amino acids of the Kunitz domain as a fusion to the first 36 amino acids of *E. coli* *recA* protein (Sancar et al., 1980, Proc. Natl. Acad. Sci. USA 77: 2611-2615). The fusion protein, which segregated into the pellet fraction of the expressing strain, was enriched by detergent and water washes. The resulting insoluble pellet was solubilized in 8 M urea and the urea was removed by dialysis against phosphate buffered saline (PBS). Dialysis caused the precipitation of a part of the solubilized material. The emulsion resulting from the dialysis was used to immunize mice. The *recA*-75 fusion represented over 30% of the protein in the emulsion.

Immunizations: Three 8-week-old Ba1b/c mice were immunized intraperitoneally with 100 μ g of immunogen emulsified with an equal volume of complete Freund's adjuvant. Then, 21 and 28 days later, mice were given additional intraperitoneal injections of 100 μ g of immunogen emulsified in an equal volume of incomplete Freund's adjuvant. After an additional seven days, the mice were boosted intravenously with 20 μ g of immunogen. Three days later the spleens were removed and somatic cell hybrids were prepared by the method of Herzenberg (Herzenberg et al., 1978, Handbook of Experimental Immunology (D. M. Weir, ed.) Blackwell Scientific Publications, Oxford, pp. 25.1-25.7) with some modifications (Lerner et al., 1980, J. Exp. Med. 152: 1085-1101).

ELISA assay: The enriched pellet fraction containing the *recA*-75 fusion was dissolved in PBS and used in an ELISA assay. As a negative control, similar pellet fraction prepared from an *E. coli* strain expressing a fusion of the same 36 amino acids of *recA* (as in *recA*-75) with a segment of APP-695 (which does not have the Kunitz insert) was used.

The ELISA assay was conducted as follows. Culture fluids from growing hybridomas were tested for the presence of specific antibody using ELISA. 1 μ g of extracts containing *recA* fusion proteins was allowed to adsorb to each well of Immunolon II EIA plates (Dynatech, Chantilly, VA) by overnight incubation at 4 °C in 50 μ l 0.01M sodium carbonate pH 9.5. Non-specific protein binding sites in each well were blocked by incubation with 200 μ l PBS containing 0.05% Tween-20 and 1% BSA followed by washing with PBS/0.05% Tween-20. Wells were then sequentially incubated with 100 μ l of hybridoma tissue culture supernatant, washed, and 100 μ l of a 1:1,000 dilution (in PBS/Tween-20) of peroxidase labelled affinity purified goat anti-mouse IgG (Kirkegaard and Perry, Gaithersburg, MD). All incubation steps, lasting one hour each, were done at room temperature. Bound peroxidase labelled "second antibody" was detected using the peroxidase substrate tetramethylbenzidine (TMB) according to the manufacturer's instructions (Kirkegaard and Perry, Gaithersburg, MD); optical density at 450 nanometers was then determined for each well. Isotypes of positive hybrid culture fluids was determined using an ELISA assay in which 1 μ g of anti-mouse Fab was adsorbed to each well of Immunolon II EIA plates followed by sequential incubations with culture supernatants and peroxidase labelled antiserum specific for mouse IgG₁, IgG_{2a}, IgG_{2b}, IgG₃, and IgM.

Characterization of the monoclonal antibodies: The antibodies were characterized on Western-blots by comparing their reactivities against the whole *recA* protein and with fusions of the first 36 amino acids of *recA* protein with the 56 and 75 amino acids of Kunitz domain. These comparisons were used to eliminate antibodies directed against the *recA* portion of the immunogen and to localize the reacting epitopes to the 56 or the 19 amino acid regions comprising the 75 amino acids of the Kunitz antigen. Three antibodies, 56-1, 56-2, 56-3 reacting with the 56 amino acid Kunitz domain were isolated by this procedure. They were then tested similarly for reactivity against the 695, 751 and 770 APP forms secreted from mammalian cells

described in Example 16. All three were found to react with human APP-751 and APP-770 from transfectants but not with the APP-695 form.

It has been observed (Weidemann et al., 1989, *supra* and Palmert et al., 1989, *supra*) that many cell lines in culture secrete all three forms of APP to various extents, with the APP-751 and APP-770 forms predominating in most cases. The 56-1 and 56-2 mAbs showed no cross-reactivity with the endogenous mouse versions of APP (Figure 32). All forms of mouse and human APPs were found to react with the 22C11 antibody raised against human 695 precursor. The 56-1 mAb was further tested against supernatants of 751 and 770 transfectants described in Example 16 and also against supernatants of mouse L-cells and COS monkey cells. As shown in Figure 33, the 56-1 mAb reacted strongly with supernatants of the 751 transfectant and with the monkey APP but not against mouse APPs either endogenous in the C127 mouse cell host or in mouse L-cells. The 22C11 mAb detected all forms of APP from all animal species tested here. Thus, the results in Figures 32 and 33 establish that the 56-1 and 56-2 mAbs are being specific for primate (human and monkey) APPs.

16

SEQUENCE LISTING

20

- (1) TITLE OF INVENTION:
Recombinant APP Minigenes for Expression in Transgenic Mice
as Models for Alzheimer's Disease

25

NUMBER OF SEQUENCES: 49

30

35

- (2) INFORMATION FOR SEQ ID NO: 1

40

- (i) SEQUENCE CHARACTERISTICS:

- (A) LENGTH: 20 base pairs
(B) TYPE: nucleic acid
(C) STRANDEDNESS: single
(D) TOPOLOGY: linear

45

50

- (ii) MOLECULE TYPE: cDNA

55

(x1) SEQUENCE DESCRIPTION: SEQ ID NO:1:

TTYTGRTGRT GCACYTSRTA

20

5

(2) INFORMATION FOR SEQ ID NO:2:

- (1) SEQUENCE CHARACTERISTICS:
 - (A) LENGTH: 17 base pairs
 - (B) TYPE: nucleic acid
 - (C) STRANDEDNESS: single
 - (D) TOPOLOGY: linear

10

(ii) MOLECULE TYPE: cDNA

15

(x1) SEQUENCE DESCRIPTION: SEQ ID NO:2:

ACRTCCTCNG CRAARAA

17

20

(2) INFORMATION FOR SEQ ID NO:3:

- (1) SEQUENCE CHARACTERISTICS:
 - (A) LENGTH: 20 base pairs
 - (B) TYPE: nucleic acid
 - (C) STRANDEDNESS: single
 - (D) TOPOLOGY: linear

25

(ii) MOLECULE TYPE: cDNA

30

(x1) SEQUENCE DESCRIPTION: SEQ ID NO:3:

TTYTGRTGRT GNACYTCRTA

20

35

(2) INFORMATION FOR SEQ ID NO:4:

- (1) SEQUENCE CHARACTERISTICS:
 - (A) LENGTH: 60 base pairs
 - (B) TYPE: nucleic acid
 - (C) STRANDEDNESS: single
 - (D) TOPOLOGY: linear

40

(ii) MOLECULE TYPE: cDNA

45

(x1) SEQUENCE DESCRIPTION: SEQ ID NO:4:

AGTACTGCAT GCGCGTGTGT GGCAGCGCCA TTCTACAAC AGCAGCCAGT ACCCCTGATG

60

50

55

(2) INFORMATION FOR SEQ ID NO:5:

- (1) SEQUENCE CHARACTERISTICS:
(A) LENGTH: 16 base pairs
(B) TYPE: nucleic acid
(C) STRANDEDNESS: single
(D) TOPOLOGY: linear

(ii) MOLECULE TYPE: cDNA

(xi) SEQUENCE DESCRIPTION: SEQ ID NO:5:

AATTCGAACC CCTTCG

16

(2) INFORMATION FOR SEQ ID NO:6:

- (1) SEQUENCE CHARACTERISTICS:
(A) LENGTH: 16 base pairs
(B) TYPE: nucleic acid
(C) STRANDEDNESS: single
(D) TOPOLOGY: linear

(ii) MOLECULE TYPE: cDNA

(xi) SEQUENCE DESCRIPTION: SEQ ID NO:6:

GCTTGGGCAA GCTCGA

16

(2) INFORMATION FOR SEQ ID NO:7:

- (1) SEQUENCE CHARACTERISTICS:
(A) LENGTH: 16 base pairs
(B) TYPE: nucleic acid
(C) STRANDEDNESS: single
(D) TOPOLOGY: linear

(ii) MOLECULE TYPE: cDNA

(xi) SEQUENCE DESCRIPTION: SEQ ID NO:7:

GATCGGGAAG CTCCCC

16

(2) INFORMATION FOR SEQ ID NO:8:

- (1) SEQUENCE CHARACTERISTICS:
(A) LENGTH: 16 base pairs
(B) TYPE: nucleic acid
(C) STRANDEDNESS: single
(D) TOPOLOGY: linear

(ii) MOLECULE TYPE: cDNA

(xi) SEQUENCE DESCRIPTION: SEQ ID NO:8:

5

CCCTTCGAAG GGCTAG

16

(2) INFORMATION FOR SEQ ID NO:9:

(i) SEQUENCE CHARACTERISTICS:

10

- (A) LENGTH: 30 base pairs
- (B) TYPE: nucleic acid
- (C) STRANDEDNESS: single
- (D) TOPOLOGY: linear

15

(ii) MOLECULE TYPE: cDNA

(ix) FEATURE:

20

- (A) NAME/KEY: CDS
- (B) LOCATION: 1..21

(ix) FEATURE:

- (A) NAME/KEY: mat_peptide
- (B) LOCATION: 1..21

25

(xi) SEQUENCE DESCRIPTION: SEQ ID NO:9:

GTC GGC GGT GTT GTC ATA GCG ACAGTATC

Val Gly Gly Val Val Ile Ala

1

5

30

30

(2) INFORMATION FOR SEQ ID NO:10:

(i) SEQUENCE CHARACTERISTICS:

35

- (A) LENGTH: 7 amino acids
- (B) TYPE: amino acid
- (D) TOPOLOGY: linear

(ii) MOLECULE TYPE: protein

40

(xi) SEQUENCE DESCRIPTION: SEQ ID NO:10:

Val Gly Gly Val Val Ile Ala

1

5

45

50

55

(2) INFORMATION FOR SEQ ID NO:11:

- (1) SEQUENCE CHARACTERISTICS:
 (A) LENGTH: 30 base pairs
 (B) TYPE: nucleic acid
 (C) STRANDEDNESS: single
 (D) TOPOLOGY: linear

(11) MOLECULE TYPE: cDNA

- (ix) FEATURE:
 (A) NAME/KEY: CDS
 (B) LOCATION: 1..18

- (ix) FEATURE:
 (A) NAME/KEY: mat_peptide
 (B) LOCATION: 1..15

(xi) SEQUENCE DESCRIPTION: SEQ ID NO:11:

GTG GCG CTC TTG TCA TAGCGACAGT GATCC
 Val Gly Val Leu Ser
 1 5

30

(2) INFORMATION FOR SEQ ID NO:12:

- (1) SEQUENCE CHARACTERISTICS:
 (A) LENGTH: 5 amino acids
 (B) TYPE: amino acid
 (D) TOPOLOGY: linear

(11) MOLECULE TYPE: protein

(xi) SEQUENCE DESCRIPTION: SEQ ID NO:12:

Val Gly Val Leu Ser
 1 5

(2) INFORMATION FOR SEQ ID NO:13:

- (1) SEQUENCE CHARACTERISTICS:
 (A) LENGTH: 33 base pairs
 (B) TYPE: nucleic acid
 (C) STRANDEDNESS: single
 (D) TOPOLOGY: linear

(11) MOLECULE TYPE: cDNA

(ix) FEATURE:
(A) NAME/KEY: CDS
(B) LOCATION: 1..21

5 (ix) FEATURE:
(A) NAME/KEY: mat_peptide
(B) LOCATION: 1..18

10 (xi) SEQUENCE DESCRIPTION: SEQ ID NO:13:

GTC GGC GGT GTT GTG TCA TAGCGACAGT GATCC
Val Gly Gly Val Val Ser
1 5

33

15 (2) INFORMATION FOR SEQ ID NO:14:

(1) SEQUENCE CHARACTERISTICS:
(A) LENGTH: 6 amino acids
(B) TYPE: amino acid
(D) TOPOLOGY: linear

20

(ii) MOLECULE TYPE: protein

(xi) SEQUENCE DESCRIPTION: SEQ ID NO:14:

25

Val Gly Gly Val Val Ser
1 5

(2) INFORMATION FOR SEQ ID NO:15:

30

(1) SEQUENCE CHARACTERISTICS:
(A) LENGTH: 30 base pairs
(B) TYPE: nucleic acid
(C) STRANDEDNESS: single
(D) TOPOLOGY: linear

35

(ii) MOLECULE TYPE: cDNA

(ix) FEATURE:
(A) NAME/KEY: CDS
(B) LOCATION: 1..18

40

(ix) FEATURE:
(A) NAME/KEY: mat_peptide
(B) LOCATION: 1..15

45

50

55

(x1) SEQUENCE DESCRIPTION: SEQ ID NO:15:

GTC GGC GGT GTT GTC TAGCGACAGT GATCG
Val Gly Gly Val Val
1 5

30

(2) INFORMATION FOR SEQ ID NO:16:

(1) SEQUENCE CHARACTERISTICS:
(A) LENGTH: 5 amino acids
(B) TYPE: amino acid
(D) TOPOLOGY: linear

(11) MOLECULE TYPE: protein

(x1) SEQUENCE DESCRIPTION: SEQ ID NO:16:

Val Gly Gly Val Val
1 5

(2) INFORMATION FOR SEQ ID NO:17:

(1) SEQUENCE CHARACTERISTICS:
(A) LENGTH: 23 base pairs
(B) TYPE: nucleic acid
(C) STRANDEDNESS: single
(D) TOPOLOGY: linear

(11) MOLECULE TYPE: cDNA

(x1) SEQUENCE DESCRIPTION: SEQ ID NO:17:

CATGGTGGGG GTGTGTTCAT AGC

23

(2) INFORMATION FOR SEQ ID NO:18:

(1) SEQUENCE CHARACTERISTICS:
(A) LENGTH: 25 base pairs
(B) TYPE: nucleic acid
(C) STRANDEDNESS: single
(D) TOPOLOGY: linear

(11) MOLECULE TYPE: cDNA

(x1) SEQUENCE DESCRIPTION: SEQ ID NO:18:

GGCCGGTGTG GTGTCATAGC GACAG

25

(2) INFORMATION FOR SEQ ID NO:19:

- (1) SEQUENCE CHARACTERISTICS:
(A) LENGTH: 24 base pairs
(B) TYPE: nucleic acid
(C) STRANDEDNESS: single
(D) TOPOLOGY: linear

(11) MOLECULE TYPE: cDNA

(x1) SEQUENCE DESCRIPTION: SEQ ID NO:19:

GGCGGTGTG TCTAGCGACA GTGA

24

(2) INFORMATION FOR SEQ ID NO:20:

- (1) SEQUENCE CHARACTERISTICS:
(A) LENGTH: 38 base pairs
(B) TYPE: nucleic acid
(C) STRANDEDNESS: single
(D) TOPOLOGY: linear

(11) MOLECULE TYPE: cDNA

(x1) SEQUENCE DESCRIPTION: SEQ ID NO:20:

GGTGTGTGCA TAGCGTAGGA TCGGTCATCA CCTTGGTG

38

(2) INFORMATION FOR SEQ ID NO:21:

- (1) SEQUENCE CHARACTERISTICS:
(A) LENGTH: 47 base pairs
(B) TYPE: nucleic acid
(C) STRANDEDNESS: single
(D) TOPOLOGY: linear

(11) MOLECULE TYPE: cDNA

(ix) FEATURE:

- (A) NAME/KEY: CDS
(B) LOCATION: 18..47

(ix) FEATURE:

- (A) NAME/KEY: mat_peptide
(B) LOCATION: 18..47

(xi) SEQUENCE DESCRIPTION: SEQ ID NO:21:

AGATCTCTGA AGTGAAG ATG GAT GGT GTT GTC ATA GCG ACA GTG ATC
Met Asp Gly Val Val Ile Ala Thr Val Ile
1 5 10

47

(2) INFORMATION FOR SEQ ID NO:22:

- (1) SEQUENCE CHARACTERISTICS:
 - (A) LENGTH: 10 amino acids
 - (B) TYPE: amino acid
 - (D) TOPOLOGY: linear

(ii) MOLECULE TYPE: protein

(xi) SEQUENCE DESCRIPTION: SEQ ID NO:22:

Met Asp Gly Val Val Ile Ala Thr Val Ile
1 5 10

(2) INFORMATION FOR SEQ ID NO:23:

- (1) SEQUENCE CHARACTERISTICS:
 - (A) LENGTH: 48 base pairs
 - (B) TYPE: nucleic acid
 - (C) STRANDEDNESS: single
 - (D) TOPOLOGY: linear

(ii) MOLECULE TYPE: cDNA

(ix) FEATURE:

- (A) NAME/KEY: CDS
- (B) LOCATION: 18..41

(ix) FEATURE:

- (A) NAME/KEY: mat_peptide
- (B) LOCATION: 18..38

(xi) SEQUENCE DESCRIPTION: SEQ ID NO:23:

AGATCTCTGA AGTGAAG ATG GAT GGT GTT GTC ATA GCG TAGGATCCGT
Met Asp Gly Val Val Ile Ala
1 5

48

(2) INFORMATION FOR SEQ ID NO:24:

- (1) SEQUENCE CHARACTERISTICS:
 - (A) LENGTH: 7 amino acids
 - (B) TYPE: amino acid
 - (D) TOPOLOGY: linear

(ii) MOLECULE TYPE: protein

(xi) SEQUENCE DESCRIPTION: SEQ ID NO:24:

5 Met Asp Gly Val Val Ile Ala
1 5

(2) INFORMATION FOR SEQ ID NO:25:

10 (i) SEQUENCE CHARACTERISTICS:
(A) LENGTH: 77 base pairs
(B) TYPE: nucleic acid
(C) STRANDEDNESS: single
(D) TOPOLOGY: linear

15 (ii) MOLECULE TYPE: cDNA

(iv) ANTI-SENSE: YES

20 (ix) FEATURE:
(A) NAME/KEY: CDS
(B) LOCATION: 22..77

(ix) FEATURE:
(A) NAME/KEY: mat_peptide
25 (B) LOCATION: 22..75

(xi) SEQUENCE DESCRIPTION: SEQ ID NO:25:

30 GCGTCTGTG GCGGGGTCT A AAT AGT TGG GTT CAG AGT GGT GAC GTC AAA 51
GAC AGT GTT CTG CAT CTG CTC AAA GA 77

35 (2) INFORMATION FOR SEQ ID NO:26:

(i) SEQUENCE CHARACTERISTICS:
(A) LENGTH: 18 amino acids
(B) TYPE: amino acid
(D) TOPOLOGY: linear

40 (ii) MOLECULE TYPE: protein

(xi) SEQUENCE DESCRIPTION: SEQ ID NO:26:

45 Ile Thr Pro Asn Leu Thr Thr Val Asp Phe Val Thr Asn Gln Met Gln
1 5 10 15

Asx Phe

50

55

(2) INFORMATION FOR SEQ ID NO:27:

- (1) SEQUENCE CHARACTERISTICS:
 - (A) LENGTH: 77 base pairs
 - (B) TYPE: nucleic acid
 - (C) STRANDEDNESS: single
 - (D) TOPOLOGY: linear

(ii) MOLECULE TYPE: cDNA

(iv) ANTI-SENSE: YES

- (ix) FEATURE:
 - (A) NAME/KEY: CDS
 - (B) LOCATION: 2..76

- (ix) FEATURE:
 - (A) NAME/KEY: mat_peptide
 - (B) LOCATION: 2..76

(xi) SEQUENCE DESCRIPTION: SEQ ID NO:27:

C GGT ACT GGC TCC TCT TGT AGG AAT AGT TGG GTT CAG ACT GGT GAC 46
 GTC AAA GAC AGT AAC TCG AAC CAC CTC TTC C 77

(2) INFORMATION FOR SEQ ID NO:28:

- (1) SEQUENCE CHARACTERISTICS:
 - (A) LENGTH: 25 amino acids
 - (B) TYPE: amino acid
 - (D) TOPOLOGY: linear

(ii) MOLECULE TYPE: protein

(xi) SEQUENCE DESCRIPTION: SEQ ID NO:28:

Thr Ser Ala Ala Thr Thr Pro Ile Thr Pro Asn Leu Thr Thr Val Asp
 1 5 10 15
 Phe Val Thr Val Arg Val Val Glu Glu
 20 25

(2) INFORMATION FOR SEQ ID NO:29:

- (1) SEQUENCE CHARACTERISTICS:
 - (A) LENGTH: 10 base pairs
 - (B) TYPE: nucleic acid
 - (C) STRANDEDNESS: single
 - (D) TOPOLOGY: linear

(ii) MOLECULE TYPE: cDNA

(x1) SEQUENCE DESCRIPTION: SEQ ID NO:29:

GGACGGAGGA

10

5 (2) INFORMATION FOR SEQ ID NO:30:

- (1) SEQUENCE CHARACTERISTICS:
(A) LENGTH: 18 base pairs
(B) TYPE: nucleic acid
(C) STRANDEDNESS: single
(D) TOPOLOGY: linear

10

(ii) MOLECULE TYPE: cDNA

15

(x1) SEQUENCE DESCRIPTION: SEQ ID NO:30:

CATGCCCTGCC TCCTCTAG

18

20

(2) INFORMATION FOR SEQ ID NO:31:

- (1) SEQUENCE CHARACTERISTICS:
(A) LENGTH: 43 base pairs
(B) TYPE: nucleic acid
(C) STRANDEDNESS: single
(D) TOPOLOGY: linear

25

(ii) MOLECULE TYPE: cDNA

30

(x1) SEQUENCE DESCRIPTION: SEQ ID NO:31:

CCTCGGCCCTT TCGTGTGTGT TTTATATGAC ATGACCCCCT TGA

43

35

(2) INFORMATION FOR SEQ ID NO:32:

- (1) SEQUENCE CHARACTERISTICS:
(A) LENGTH: 40 base pairs
(B) TYPE: nucleic acid
(C) STRANDEDNESS: single
(D) TOPOLOGY: linear

40

(ii) MOLECULE TYPE: cDNA

45

(x1) SEQUENCE DESCRIPTION: SEQ ID NO:32:

CACCCCTGTT GTCAATGCCT CTGGGTTTCC GCCAGTTTCG

40

50

55

(2) INFORMATION FOR SEQ ID NO:33:

- (1) SEQUENCE CHARACTERISTICS:
(A) LENGTH: 35 base pairs
(B) TYPE: nucleic acid
(C) STRANDEDNESS: single
(D) TOPOLOGY: linear

(11) MOLECULE TYPE: cDNA

(x1) SEQUENCE DESCRIPTION: SEQ ID NO:33:

ATGAACTCA TATCCTGAGT CCATGTCGGA ATTCT

(2) INFORMATION FOR SEQ ID NO:34:

- (1) SEQUENCE CHARACTERISTICS:
(A) LENGTH: 24 base pairs
(B) TYPE: nucleic acid
(C) STRANDEDNESS: single
(D) TOPOLOGY: linear

(11) MOLECULE TYPE: cDNA

(x1) SEQUENCE DESCRIPTION: SEQ ID NO:34:

GGCAACATGA TTAGTGAACC AAGG

(2) INFORMATION FOR SEQ ID NO:35:

- (1) SEQUENCE CHARACTERISTICS:
(A) LENGTH: 29 base pairs
(B) TYPE: nucleic acid
(C) STRANDEDNESS: single
(D) TOPOLOGY: linear

(11) MOLECULE TYPE: cDNA

(x1) SEQUENCE DESCRIPTION: SEQ ID NO:35:

GGAGGCTGCT CTGCTGGTCT TCAATTACC

(2) INFORMATION FOR SEQ ID NO:36:

- (1) SEQUENCE CHARACTERISTICS:
 - (A) LENGTH: 31 base pairs
 - (B) TYPE: nucleic acid
 - (C) STRANDEDNESS: single
 - (D) TOPOLOGY: linear

(ii) MOLECULE TYPE: cDNA

(xi) SEQUENCE DESCRIPTION: SEQ ID NO:36:

AAGGGTTTGT CCAGGCATGC CTCCTCATC C

31

(2) INFORMATION FOR SEQ ID NO:37:

- (1) SEQUENCE CHARACTERISTICS:
 - (A) LENGTH: 36 base pairs
 - (B) TYPE: nucleic acid
 - (C) STRANDEDNESS: single
 - (D) TOPOLOGY: linear

(ii) MOLECULE TYPE: cDNA

(xi) SEQUENCE DESCRIPTION: SEQ ID NO:37:

CCTGGCGTTA CCCAACTTAA TCGCCTTGCA GCACAT

36

(2) INFORMATION FOR SEQ ID NO:38:

- (1) SEQUENCE CHARACTERISTICS:
 - (A) LENGTH: 35 base pairs
 - (B) TYPE: nucleic acid
 - (C) STRANDEDNESS: single
 - (D) TOPOLOGY: linear

(ii) MOLECULE TYPE: cDNA

(xi) SEQUENCE DESCRIPTION: SEQ ID NO:38:

AATAAATGTG AGCGAGTAAC AACCCGTCGG ATTCT

35

(2) INFORMATION FOR SEQ ID NO:39:

- (1) SEQUENCE CHARACTERISTICS:
 - (A) LENGTH: 80 base pairs
 - (B) TYPE: nucleic acid
 - (C) STRANDEDNESS: single
 - (D) TOPOLOGY: linear

(ii) MOLECULE TYPE: cDNA

(xi) SEQUENCE DESCRIPTION: SEQ ID NO:39:

GAGATAGAAT ACATTACTGA TGTGTGGATT AATCAAGTT CAGGCATCTA CTGTGTTAC 60
AGCACAGCTG GCGGTCCATA 80

(2) INFORMATION FOR SEQ ID NO:40:

- (1) SEQUENCE CHARACTERISTICS:
(A) LENGTH: 60 base pairs
(B) TYPE: nucleic acid
(C) STRANDEDNESS: single
(D) TOPOLOGY: linear

(ii) MOLECULE TYPE: cDNA

(xi) SEQUENCE DESCRIPTION: SEQ ID NO:40:

CGCGGGTGGG GCTTAGTTCT GCATTTCCTC AAAGAACTTC TAAGTTGGAT AGGTICCAAG 60

(2) INFORMATION FOR SEQ ID NO:41:

- (1) SEQUENCE CHARACTERISTICS:
(A) LENGTH: 12 amino acids
(B) TYPE: amino acid
(D) TOPOLOGY: linear

(ii) MOLECULE TYPE: peptide

(v) FRAGMENT TYPE: internal

(xi) SEQUENCE DESCRIPTION: SEQ ID NO:41:

Thr Val Phe Asp Val Thr Thr Leu Asn Pro Thr Ile
1 5 10

(2) INFORMATION FOR SEQ ID NO:42:

- (1) SEQUENCE CHARACTERISTICS:
(A) LENGTH: 3353 base pairs
(B) TYPE: nucleic acid
(C) STRANDEDNESS: single
(D) TOPOLOGY: linear

(ii) MOLECULE TYPE: cDNA

(ix) FEATURE:
 (A) NAME/KEY: CDS
 (B) LOCATION: 147..2234

5 (ix) FEATURE:
 (A) NAME/KEY: mat_peptide
 (B) LOCATION: 147..2231

10 (xi) SEQUENCE DESCRIPTION: SEQ ID NO:42:

AGTTTCCTCG GCAGGGTAG GCGAGAGCAC GCGGAGGAGC GTGCGCGGGG CCCCCGGAGA	60
CGCGGGGGGT GCGGGCGGG GCAGAGCAAG CACCGGGCGG ATCCCACTCG CACAGCAGCG	120
CACTCGGTGC CCCGCCAGG GTCGGC ATG CTG CCC GGT TTC GCA CTG CTC GTC	173
Met Leu Pro Gly Leu Ala Leu Leu Leu	
1 5	
CTG GCC GCC TGG ACG GCT CGG GCG CTG GAG GTA CCC ACT GAT GGT AAT	221
Leu Ala Ala Trp Thr Ala Arg Ala Leu Glu Val Pro Thr Asp Gly Asn	
10 15 20 25	
GCT GGC CTG CTG GCT GAA CCC CAG ATT GCC ATG TTC TGT CGC AGA GTG	269
Ala Gly Leu Leu Ala Glu Pro Gln Ile Ala Met Phe Cys Gly Arg Leu	
30 35 40	
AAC ATG CAC ATG AAT GTC CAG AAT GGG AAG TCG GAT TCA GAT CCA TCA	317
Asn Met His Met Asn Val Gln Asn Gly Lys Trp Asp Ser Asp Pro Ser	
45 50 55	
GGG ACC AAA ACC TGC ATT GAT ACC AAG GAA GGC ATC CTG CAG TAT TGC	365
Gly Thr Lys Thr Cys Ile Asp Thr Lys Glu Gly Ile Leu Gln Tyr Cys	
60 65 70	
CAA GAA GTC TAC CCT GAA CTG CAG ATC ACC AAT GTG GTA GAA GCC AAC	413
Gln Glu Val Tyr Pro Glu Leu Gln Ile Thr Asn Val Val Glu Ala Asn	
75 80 85	
CAA CCA GTG ACC ATC CAG AAC TGG TGC AAG CGG GGC CGC AAG CAG TGC	461
Gln Pro Val Thr Ile Gln Asn Trp Cys Lys Arg Gly Arg Lys Gln Cys	
90 95 100 105	
AAG ACC CAT CCC CAC TTT GTG ATT CCC TAC CGC TGC TTA GTT GGT GAG	509
Lys Thr His Pro His Phe Val Ile Pro Tyr Arg Cys Leu Val Gly Glu	
110 115 120	
TTT GTA AGT GAT GCC CTT CTC GTT CCT GAC AAG TGC AAA TTC TTA CAC	557
Phe Val Ser Asp Ala Leu Leu Val Pro Asp Lys Cys Lys Phe Leu His	
125 130 135	
CAG GAG AGG ATG GAT GTT TGC GAA ACT CAT CTT CAC TGC CAC ACC GTC	605
Gln Glu Arg Met Asp Val Cys Glu Thr His Leu His Trp His Thr Val	
140 145 150	

55

	GCC AAA GAG ACA TGC AGT GAG AAG AGT ACC AAC TTG CAT GAC TAC GCC	653
	Ala Lys Glu Thr Cys Ser Glu Lys Ser Thr Asn Leu His Asp Tyr Gly	
	155 160 165	
5	ATG TTG CTG CCC TGC GGA ATT GAC AAG TTC CGA GGG GTA GAG TTT GTG	701
	Met Leu Leu Pro Cys Gly Ile Asp Lys Phe Arg Gly Val Glu Phe Val	
	170 175 180 185	
10	TGT TGC CCA CTG GCT GAA GAA AGT GAC AAT GTG GAT TCT GCT GAT GCC	749
	Cys Cys Pro Leu Ala Glu Glu Ser Asp Asn Val Asp Ser Ala Asp Ala	
	190 195 200	
15	GAG GAG GAT GAC TCG GAT GTC TCG TCG GGC GCA GCA GAC ACA GAC TAT	797
	Glu Glu Asp Asp Ser Asp Val Trp Trp Gly Gly Ala Asp Thr Asp Tyr	
	205 210 215	
20	GCA GAT GGG AGT GAA GAC AAA GTA GTA GAA GTA GCA GAG GAG GAA GAA	845
	Ala Asp Gly Ser Glu Asp Lys Val Val Glu Val Ala Glu Glu Glu Glu	
	220 225 230	
25	GTG GCT GAG GTG GAA GAA GAA GAA GCC GAT GAT GAC GAG GAC GAT GAG	893
	Val Ala Glu Val Glu Glu Glu Glu Ala Asp Asp Asp Glu Asp Asp Glu	
	235 240 245	
30	GAT GGT GAT GAG GTA GAG GAA GAG GCT GAG GAA CCC TAC GAA GAA GCC	941
	Asp Gly Asp Glu Val Glu Glu Glu Ala Glu Glu Pro Tyr Glu Glu Ala	
	250 255 260 265	
35	ACA GAG AGA ACC ACC AGC ATT GCC ACC ACC ACC ACC ACC ACC ACA GAG	989
	Thr Glu Arg Thr Thr Ser Ile Ala Thr Thr Thr Thr Thr Thr Thr Glu	
	270 275 280	
40	TCT GTG GAA GAG GTG GTT CGA GTT CCT ACA ACA GCA GCC AGT ACC CCT	1037
	Ser Val Glu Glu Val Val Arg Val Pro Thr Thr Ala Ala Ser Thr Pro	
	285 290 295	
45	GAT GCC GTT GAC AAG TAT CTC GAG ACA CCT GGG GAT GAG AAT GAA CAT	1085
	Asp Ala Val Asp Lys Tyr Leu Glu Thr Pro Gly Asp Glu Asn Glu His	
	300 305 310	
50	GCC CAT TTC CAG AAA GCC AAA GAG AGG CTT GAG GCC AAG CAC CGA GAG	1133
	Ala His Phe Gln Lys Ala Lys Glu Arg Leu Glu Ala Lys His Arg Glu	
	315 320 325	
55	AGA ATG TCC CAG GTC ATG AGA GAA TGG GAA GAG GCA GAA CGT CAA GCA	1181
	Arg Met Ser Gln Val Met Arg Glu Trp Glu Glu Ala Glu Arg Gln Ala	
	330 335 340 345	
60	AAC AAC TTG CCT AAA GCT GAT AAG AAG GCA GTT ATC CAG CAT TTC CAG	1229
	Lys Asn Leu Pro Lys Ala Asp Lys Lys Ala Val Ile Gln His Phe Gln	
	350 355 360	
65	GAG AAA GTG GAA TCT TTG GAA CAG GAA GCA GCC AAC GAG AGA CAG CAG	1277
	Glu Lys Val Glu Ser Leu Glu Gln Glu Ala Ala Asn Glu Arg Gln Gln	
	365 370 375	

EP 0 451 700 A1

	CTG GTG GAG ACA CAC ATG GCC AGA GTG GAA GCC ATG CTC AAT GAC CGC	1325
	Leu Val Glu Thr His Met Ala Arg Val Glu Ala Met Leu Asn Asp Arg	
	380 385 390	
5	CGC CGC CTG GCC CTG GAG AAC TAC ATG ACC GCT CTG CAG GCT GTT CCT	1373
	Arg Arg Leu Ala Leu Glu Asn Tyr Ile Thr Ala Leu Gln Ala Val Pro	
	395 400 405	
10	CCT CGG CCT CGT CAC GTG TTC AAT ATG CTA AAG AAG TAT GTC CGC GCA	1421
	Pro Arg Pro Arg His Val Phe Asn Met Leu Lys Lys Tyr Val Arg Ala	
	410 415 420 425	
15	GAA CAG AAG GAC AGA CAG CAC ACC CTA AAG CAT TTC GAG CAT GTG CGC	1469
	Glu Gln Lys Asp Arg Gln His Thr Leu Lys His Phe Glu His Val Arg	
	430 435 440	
20	ATG GTG GAT CCC AAG AAA GCC GCT CAG ATC CGG TCC CAG GTT ATG ACA	1517
	Met Val Asp Pro Lys Lys Ala Ala Gln Ile Arg Ser Gln Val Met Thr	
	445 450 455	
25	CAC CTC CGT GTG ATT TAT GAG CGC ATG AAT CAG TCT CTC TCC GTG GTC	1565
	His Leu Arg Val Ile Tyr Glu Arg Met Asn Gln Ser Leu Ser Leu Leu	
	460 465 470	
30	TAC AAC CTG CCT GCA GTG GCC GAG GAG ATT CAG GAT GAA GTT CAT CAG	1613
	Tyr Asn Val Pro Ala Val Ala Glu Glu Ile Gln Asp Glu Val Asp Glu	
	475 480 485	
35	CTG CTT CAG AAA GAG CAA AAC TAT TCA GAT GAC GTC TTG GCC AAC ATG	1661
	Leu Leu Gln Lys Glu Gln Asn Tyr Ser Asp Asp Val Leu Ala Asn Met	
	490 495 500 505	
40	ATT AGT GAA CCA AGG ATC ACT TAC GGA AAC GAT GCT CTC ATG CCA TCT	1709
	Ile Ser Glu Pro Arg Ile Ser Tyr Gly Asn Asp Ala Leu Met Pro Ser	
	510 515 520	
45	TTG ACC GAA ACG AAA ACC ACC GTG CAG CTC CTT CCC GTG AAT GGA GAG	1757
	Leu Thr Glu Thr Lys Thr Thr Val Glu Leu Leu Pro Val Asn Gly Glu	
	525 530 535	
50	TTC AGC CTG GAC GAT CTC CAG CCG TGG CAT TCT TTT GGG GCT CAC TCT	1805
	Phe Ser Leu Asp Asp Leu Gln Pro Trp His Ser Phe Gly Ala Asp Ser	
	540 545 550	
55	GTG CCA GCC AAC ACA GAA AAC GAA GTT GAG CCT GTT CAT CCC CGC CCT	1853
	Val Pro Ala Asn Thr Glu Asn Glu Val Glu Pro Val Asp Ala Arg Pro	
	555 560 565	
60	GCT GCC GAC CGA GGA CTG ACC ACT CGA CCA GGT TCT GGG TTG ACA AAT	1901
	Ala Ala Asp Arg Gly Leu Thr Thr Arg Pro Gly Ser Gly Leu Thr Asn	
	570 575 580 585	
65	ATC AAG ACC GAG GAG ATC TCT GAA GTG AAG ATG GAT GCA GAA TTC CGA	1949
	Ile Lys Thr Glu Glu Ile Ser Glu Val Lys Met Asp Ala Glu Phe Arg	
	590 595 600	

	CAT GAC TCA GGA TAT GAA GTT CAT CAT CAA AAA TTG GTG TTC TTT GCA His Asp Ser Gly Tyr Glu Val His His Gln Lys Leu Val Phe Phe Ala 605 610 615	1997
5	GAA GAT GTG GGT TCA AAC AAA GGT GCA ATC ATT GGA CTC ATG GTG GGC Glu Asp Val Gly Ser Asn Lys Gly Ala Ile Ile Gly Leu Met Val Gly 620 625 630	2045
10	GGT GTT GTC AIA GCG ACA GTG ATC GTC ATC ACC TTG GTG ATG CTC AAG Gly Val Val Ile Ala Thr Val Ile Val Ile Thr Leu Val Met Leu Lys 635 640 645	2093
15	AAG AAA CAG TAC ACA TCC ATT CAT CAT GGT GTG GTG GAG GTT GAC GCC Lys Lys Gln Tyr Thr Ser Ile His His Gly Val Val Glu Val Asp Ala 650 655 660 665	2141
20	GCT GTC ACC CCA CAG GAG CGC CAC CTG TCC AAG ATG CAG CAG AAC GGC Ala Val Thr Pro Glu Glu Arg His Leu Ser Lys Met Gln Gln Asn Gly 670 675 680	2189
25	TAC GAA AAT CCA ACC TAC AAG TTC TTT GAG CAG ATG CAG AAC TAGACCCCC Tyr Glu Asn Pro Thr Tyr Lys Phe Phe Glu Gln Met Gln Asn 685 690 695	2241
30	CCACAGCAGC CTCTGAAGTT GGACAGCAA ACCATTGCTT CACTACCCAT CGGTGCCAT TTATAGAATA ATGTGGGAAG AAACAAACCC GTTTTATCAT TTACTCATTI TCGCCTTTTG ACAGGTGTGC TGTAACACAA GTAGATGCCT GAAGTTGAAT TAATCCACAC ATCAGTAATG TATTCTATCT CTCTTIACAT TTTGGTCTCT ATACTIACATT ATTAATGGGT TTTGTGTACT GTAAACAATT TAGCTGTATC AAAGTAGTGC ATGAATAGAT TCTCTCCTGA TTATTIATCA CATAGCCCCT TAGCCAGTTG TATATTATTC TTGTGGTTTG TGACCCAATT AAGTCCTACT TTACATAIGC TTTAAGAATC GATGGGGGAT GCTTCATGTC AACGTGGGAG TTCAGGTGCT TCTCTGGCCT AAGTATTCCT TTCCTGATCA CTATGCATTI TAAAGTIAAA CTTTTTAAAG TATTTCAGAT GCTTTAGAGA GATTTTTTTT CCATGACTGC ATTTTACTGT ACAGATTGCT GCTTCIGCTA TATTTGTGAT ATAGGAATTA AGAGGATACA CACGTTTGTI TCTTCGTGCC TGTTTTATGT GCACACATTI GCCATTGAGA CTTCAAGCTT TTCTTTTTTT GTCCACGTAT CTTTGGCTCT TTGATAAAGA AAAGAATCCC TGTTCAATGT AAGCACTTTT ACGGGGGGGG TGGGGAGGGG TGCTCTGCTG GTCTTCAATT ACCAAGAATT CTCCAAAACA ATTTTCTGCA GGATGATTGT ACAGAATCAT TGCTTATGAC ATGATCGCTI TCTACACTGT ATTACATAAA TAAATTAAT AAAATAACCC CGGGCAAGAC TTTTCTTTGA AGGATGACTA CAGACATTAA ATAATCGAAG TAATTTTGGG TGGGGAGAAG AGGCAGATTC AATTTCTTTI AACCAGTCTG	2301
35		2361
40		2421
45		2481
50		2541
55		2601
		2661
		2721
		2781
		2841
		2901
		2961
		3021
		3081
		3141
		3201

AAGTTTCATT TATGATACAA AAGAAGATGA AAATGGAAGT GGCAATAIAA GGGGATCAGG 3261
 AAGGGATGCC TGGACAAACC CTTCTITTA A GAITGIGTCTT CAATTIGTAT AAAATGGTGT 3321
 5 TITCATGTAA ATAAATACAT TCTTGGAGGA GC 3353

(2) INFORMATION FOR SEQ ID NO:43:

(1) SEQUENCE CHARACTERISTICS:
 (A) LENGTH: 695 amino acids
 (B) TYPE: amino acid
 (D) TOPOLOGY: linear

(ii) MOLECULE TYPE: protein

(xi) SEQUENCE DESCRIPTION: SEQ ID NO:43:

Met Leu Pro Gly Leu Ala Leu Leu Leu Ala Ala Ala Trp Thr Ala Arg
 1 5 10 15
 Ala Leu Glu Val Pro Thr Asp Gly Asn Ala Gly Leu Leu Ala Glu Pro
 20 25 30
 Gln Ile Ala Met Phe Cys Gly Arg Leu Asn Met His Met Asn Val Gln
 35 40 45
 Asn Gly Lys Trp Asp Ser Asp Pro Ser Gly Thr Lys Thr Cys Ile Asp
 50 55 60
 Thr Lys Glu Gly Ile Leu Gln Tyr Cys Gln Glu Val Tyr Pro Glu Leu
 65 70 75 80
 Gln Ile Thr Asn Val Val Glu Ala Asn Gln Pro Val Thr Ile Gln Asn
 85 90 95
 Trp Cys Lys Arg Gly Arg Lys Gln Cys Lys Thr His Pro His Phe Val
 100 105 110
 Ile Pro Tyr Arg Cys Leu Val Gly Glu Phe Val Ser Asp Ala Leu Leu
 115 120 125
 Val Pro Asp Lys Cys Lys Phe Leu His Gln Glu Arg Met Asp Val Cys
 130 135 140
 Glu Thr His Leu His Trp His Thr Val Ala Lys Glu Thr Cys Ser Glu
 145 150 155 160
 Lys Ser Thr Asn Leu His Asp Tyr Gly Met Leu Leu Pro Cys Gly Ile
 165 170 175
 Asp Lys Phe Arg Gly Val Glu Phe Val Cys Cys Pro Leu Ala Glu Glu
 180 185 190
 Ser Asp Asn Val Asp Ser Ala Asp Ala Glu Glu Asp Asp Ser Asp Val
 195 200 205

Trp Trp Gly Gly Ala Asp Thr Asp Tyr Ala Asp Gly Ser Glu Asp Lys
 210 215 220
 5 Val Val Glu Val Ala Glu Glu Glu Glu Val Ala Glu Val Glu Glu Glu
 225 230 235 240
 Glu Ala Asp Asp Asp Glu Asp Asp Glu Asp Gly Asp Glu Val Glu Glu
 245 250 255
 10 Glu Ala Glu Glu Pro Tyr Glu Glu Ala Thr Glu Arg Thr Thr Ser Ile
 260 265 270
 Ala Thr Thr Thr Thr Thr Thr Thr Glu Ser Val Glu Glu Val Val Arg
 275 280 285
 15 Val Pro Thr Thr Ala Ala Ser Thr Pro Asp Ala Val Asp Lys Tyr Leu
 290 295 300
 Glu Thr Pro Gly Asp Glu Asn Glu His Ala His Phe Gln Lys Ala Lys
 305 310 315 320
 20 Glu Arg Leu Glu Ala Lys His Arg Glu Arg Met Ser Gln Val Met Arg
 325 330 335
 Glu Trp Glu Glu Ala Glu Arg Gln Ala Lys Asn Leu Pro Lys Ala Asp
 340 345 350
 25 Lys Lys Ala Val Ile Gln His Phe Gln Glu Lys Val Glu Ser Leu Glu
 355 360 365
 Gln Glu Ala Ala Asn Glu Arg Gln Gln Leu Val Glu Thr His Met Ala
 370 375 380
 30 Arg Val Glu Ala Met Leu Asn Asp Arg Arg Arg Leu Ala Leu Glu Asn
 385 390 395 400
 Tyr Ile Thr Ala Leu Gln Ala Val Pro Pro Arg Pro Arg His Val Phe
 405 410 415
 35 Asn Met Leu Lys Lys Tyr Val Arg Ala Glu Gln Lys Asp Arg Gln His
 420 425 430
 40 Thr Leu Lys His Phe Glu His Val Arg Met Val Asp Pro Lys Lys Ala
 435 440 445
 Ala Gln Ile Arg Ser Gln Val Met Thr His Leu Arg Val Ile Tyr Glu
 450 455 460
 45 Arg Met Asn Gln Ser Leu Ser Leu Leu Tyr Asn Val Pro Ala Val Ala
 465 470 475 480
 Glu Glu Ile Gln Asp Glu Val Asp Glu Leu Leu Gln Lys Glu Gln Asn
 485 490 495

50

55

Tyr Ser Asp Asp Val Leu Ala Asn Met Ile Ser Glu Pro Arg Ile Ser
 500 505 510
 5 Tyr Gly Asn Asp Ala Leu Met Pro Ser Leu Thr Glu Thr Lys Thr Thr
 515 520 525
 Val Glu Leu Leu Pro Val Asn Gly Glu Phe Ser Leu Asp Asp Leu Gln
 530 535 540
 10 Pro Trp His Ser Phe Gly Ala Asp Ser Val Pro Ala Asn Thr Glu Asn
 545 550 555 560
 Glu Val Glu Pro Val Asp Ala Arg Pro Ala Ala Asp Arg Gly Leu Thr
 565 570 575
 15 Thr Arg Pro Gly Ser Gly Leu Thr Asn Ile Lys Thr Glu Glu Ile Ser
 580 585 590
 Glu Val Lys Met Asp Ala Glu Phe Arg His Asp Ser Gly Tyr Glu Val
 595 600 605
 20 His His Gln Lys Leu Val Phe Phe Ala Glu Asp Val Gly Ser Asn Lys
 610 615 620
 Gly Ala Ile Ile Gly Leu Met Val Gly Gly Val Val Ile Ala Thr Val
 625 630 635 640
 25 Ile Val Ile Thr Leu Val Met Leu Lys Lys Lys Gln Tyr Thr Ser Ile
 645 650 655
 His His Gly Val Val Glu Val Asp Ala Ala Val Thr Pro Glu Glu Arg
 660 665 670
 30 His Leu Ser Lys Met Gln Gln Asn Gly Tyr Glu Asn Pro Thr Tyr Lys
 675 680 685
 Phe Phe Glu Gln Met Gln Asn
 690 695
 35

(2) INFORMATION FOR SEQ ID NO:44:

- (1) SEQUENCE CHARACTERISTICS:
- (A) LENGTH: 1575 base pairs
 - (B) TYPE: nucleic acid
 - (C) STRANDEDNESS: single
 - (D) TOPOLOGY: linear

(ii) MOLECULE TYPE: cDNA

- (ix) FEATURE:
- (A) NAME/KEY: CDS
 - (B) LOCATION: 148..537

(ix) FEATURE:

(A) NAME/KEY: mat_peptide

(B) LOCATION: 148..534

5

(xi) SEQUENCE DESCRIPTION: SEQ ID NO:44:

AGTTTCCTCG GCAGCGGTAG GCGAGAGCAC GCGGAGGAGC GTGCCCGGGC CCCCCGGGAG 60
 10 ACGCGCGGGG TGGCGGGCGG GGCAGAGCAA GGACCGCGCG GATCCCACTC GCACAGCACC 120
 GCACTCGGTG CCCCCGGCAG GGTCCGG ATG CTG CCC GGT TTG GCA CTG CTC 171
 Met Leu Pro Gly Leu Ala Leu Leu
 1 5
 15 CTG CTG GCC GCC TGG ACC GCT CGG CGC CTG GAG GTA CGG ACG GAG GAG 219
 Leu Leu Ala Ala Trp Thr Ala Arg Ala Leu Glu Val Arg Thr Glu Glu
 10 15 20
 20 ATC TCT GAA GTG AAG ATG GAT GCA GAA TTC CGA CAT GAC TCA GGA TAT 267
 Ile Ser Glu Val Lys Met Asp Ala Glu Phe Arg His Asp Ser Gly Tyr
 25 30 35 40
 GAA GTT CAT CAT CAA AAA TTG GTG TTC TTT GCA GAA GAT GTG GGT TCA 315
 Glu Val His His Gln Lys Leu Val Phe Phe Ala Glu Asp Val Gly Ser
 45 50 55
 25 AAC AAA GGT GCA ATC ATT GGA CTC ATG GTG GGC GGT GTT GTC ATA GCC 363
 Asn Lys Gly Ala Ile Ile Gly Leu Met Val Gly Gly Val Val Ile Ala
 60 65 70
 30 ACA GTG ATC GTC ATC ACC TTG GTG ATG CTG AAG AAG AAA CAG TAC ACA 411
 Thr Val Ile Val Ile Thr Leu Val Met Leu Lys Lys Lys Gln Tyr Thr
 75 80 85
 35 TCC ATT CAT CAT GGT GTG GTG GAG GTT GAC GCC GCT GTC ACC CCA GAG 459
 Ser Ile His His Gly Val Val Glu Val Asp Ala Ala Val Thr Pro Glu
 90 95 100
 GAG CGC CAC CTG TCC AAG ATG CAG CAG AAG GGC TAC GAA AAT CCA ACC 507
 Glu Arg His Leu Ser Lys Met Gln Gln Asn Gly Tyr Glu Asn Pro Thr
 105 110 115 120
 40 TAC AAG TTC TTT GAG CAG ATG CAG AAC TAGACCCCGG CCACAGCAGC 554
 Tyr Lys Phe Phe Glu Gln Met Gln Asn
 125 130
 45 CTGTGAAGTT GCACAGCAAA ACCATTGCTT CACTACCCAT CCGTGTCCAT TTATAGAATA 614
 AIGTGGGAAG AAACAAACCC CTTTTATGAT TTAICTAITA TCGCCTTTTC ACAGCTGTGC 674
 TGTAAACAAA GTAGATGCCCT GAACCTGAAT TAATCCACAC ATCAGTAATG TATICTATCT 734
 60 CICTTIACAT TITGGTCTGT ATACTACATT ATTAATGGGT TITGTGTACT GTAAAGAATT 794
 TAGCTGTATC AAAC TAGTGC ATGAATAGAT TCTCTCCTGA TTATTATCA CATAGCCCTT 854

55

5 TAGCCAGTTG TATATTATTC TTGTGGTTTG TGACCCAATT AAGTCCTACT TTACATATGC 914
 TTTAAGAATC GATGGGGGAT GCTTCATGTG AACGTGGGAG TTCAGCTGCT TCTCTTGCCT 974
 AAGTATTCTT TTCCTGATCA CTATGCATTT TAAAGTIAAA CATTITTAAG TATTTICAGAT 1034
 GCTTTAGAGA GATTTTTTTT CCATGACTGC ATTTTACTGT ACAGATIGCT GCTTCTGCTA 1094
 TATTTGTGAT ATAGGAATTA AGAGGATACA CAGGTTTGTG TCTTGTGCGC TGTTTTATGT 1154
 10 GCACACATTA GGCAITGAGA CTTCAAGCTT TCTTTTTTTT GTCCACGTAT CTTTGGGTCT 1214
 TTGATAAAGA AAAGAATCCC TGTTCAITGT AAGCAGTTTT ACGGGGGGGG TGGGGAGGGG 1274
 TGCTCTGCTG GTCTTCAATT ACCAAGAATT CTCCAAAACA ATTTTCTGCA GGATGATTGT 1334
 15 ACAGAATCAT TGCTTATGAC ATGATCGCTT ICTACACTGT ATTACATAAA TAAATTAAT 1394
 AAAATAACCC CGGGCAAGAC TTTTCTTTGA AGGATGACTA CAGACATTAA ATAATCGAAG 1454
 TAATTTTGGG TGGGGAGAAG AGGCAGATTC AATTTTCTTT AACCAGTCTG AAGTTTCATT 1514
 20 TATGATACAA AAGAAGATGA AAATGGAAGT GCCAATATAA CGGGATGAGG AAGGCACCAT 1574
 C 1575

(2) INFORMATION FOR SEQ ID NO:45:

- (1) SEQUENCE CHARACTERISTICS:
- (A) LENGTH: 129 amino acids
- (B) TYPE: amino acid
- (D) TOPOLOGY: linear

(ii) MOLECULE TYPE: protein

(xi) SEQUENCE DESCRIPTION: SEQ ID NO:45:

35 Met Leu Pro Gly Leu Ala Leu Leu Leu Ala Ala Trp Thr Ala Arg
 1 5 10 15
 40 Ala Leu Glu Val Arg Thr Glu Glu Ile Ser Glu Val Lys Met Asp Ala
 20 25 30
 45 Glu Phe Arg His Asp Ser Gly Tyr Glu Val His His Gln Lys Leu Val
 35 40 45
 Phe Phe Ala Glu Asp Val Gly Ser Asn Lys Gly Ala Ile Ile Gly Leu
 50 55 60
 50 Met Val Gly Gly Val Val Ile Ala Thr Val Ile Val Ile Thr Leu Val
 65 70 75 80
 Met Leu Lys Lys Lys Gln Tyr Thr Ser Ile His His Gly Val Val Glu
 85 90 95

Val Asp Ala Ala Val Thr Pro Glu Glu Arg His Leu Ser Lys Met Gln
 100 105 110

5 Gln Asn Gly Tyr Glu Asn Pro Thr Tyr Lys Phe Phe Glu Gln Met Gln
 115 120 125

Asn

10

(2) INFORMATION FOR SEQ ID NO:46:

- (i) SEQUENCE CHARACTERISTICS:
 - (A) LENGTH: 1574 base pairs
 - (B) TYPE: nucleic acid
 - (C) STRANDEDNESS: single
 - (D) TOPOLOGY: linear

15

(ii) MOLECULE TYPE: cDNA

20

(ix) FEATURE:

- (A) NAME/KEY: CDS
- (B) LOCATION: 148..360

(ix) FEATURE:

25

- (A) NAME/KEY: mat_peptide
- (B) LOCATION: 148..357

(xi) SEQUENCE DESCRIPTION: SEQ ID NO:46:

30

AGTTTCCTCG GCAGCGGTAG GCGAGACCAC GCGCAGGACC GTGCCCGGGC GCCCCGGCAG 60

ACCGCGGGCG TGGCGGGCGG GCGAGAGCAA GCACCGGGCG GATCCCACTC GCACAGCAGC 120

35

GCACTCGGTG CCCCCGGCAG GGTCCGG ATG CTG CCC GGT TTG GCA CTG CTC 171
 Met Leu Pro Gly Leu Ala Leu Leu
 1 5

40

CTG CTG GCC GCC TGG ACG GCT CGG GCG CTG GAG GTA CGG ACG GAG CAG 219
 Leu Leu Ala Ala Trp Thr Ala Arg Ala Leu Glu Val Arg Thr Glu Glu
 10 15 20

ATC TCT GAA GTG AAG ATG GAT GCA GAA TTC CGA CAT GAC TCA GGA TAT 267
 Ile Ser Glu Val Lys Met Asp Ala Glu Phe Arg His Asp Ser Gly Tyr
 25 30 35 40

45

GAA GTT CAT CAT CAA AAA TTG GTG TTC TTT GCA GAA GAT GTG GGT TCA 315
 Glu Val His His Gln Lys Leu Val Phe Ala Glu Asp Val Gly Ser
 45 50 55

50

AAC AAA GGT GCA ATC ATT GGA CTC ATG GTG GGC GGT GTT GTC TAGCCACAGT 367
 Asn Lys Gly Ala Ile Ile Gly Leu Met Val Gly Gly Val Val
 60 65 70

55

5
 10
 15
 20
 25
 30
 35
 40
 45
 50
 55

GATCGTCAIC ACCTTGGIGA TGCTGAAGAA GAAACAGTAC ACATCCATTG ATCATGGTGT 427
 GGTGGAGGTT GACGCCGCTG TCACCCGAGA GGAGCGCCAC CTGTCCAAGA TGCAGCAGAA 487
 CGGCTACGAA AATCCAACCT ACAAGTTCIT TGACCAGATG CAGAACTAGA CCCCAGCCAC 547
 AGCAGCCTCT CAAGTTGGAC AGCAAAACCA TTGCTTCACT ACCCATCGGT GTCCATTIAT 607
 AGAATAATGT CGGAAGAAAC AAACCCGTTT TATGATTIAC TCATTATCGG CTTTTCACAG 667
 CTGTGCTGTA ACACAAGTAG ATGCCTGAAC TTGAATTAAT CCACACATCA GTAATGIATT 727
 CTATCTCTCT TTACATTTTG GTCTCTATAC TACATTATTA ATGGGTTTTG TGTACTGTAA 787
 AGAATTIAGC TGTATCAAAC TAGTGCATGA ATAGATTCTC TCCTGATTAT TTATCACATA 847
 GCCCCTIAGC CAGTTCIATA TTATTCTTGT GGTITGTGAC CCAATTAAGT CCTACTTIAC 907
 ATATGCTTIA AGAATCGATG GGGGATGCTT CATGTGAACG TGGGAGTICA GCTGCTTCTC 967
 TTCCTAAGT ATTCTTTCC TGATCACTIAT GCATTTTAAA GTTAAACATT TTTAAGTIAT 1027
 TCAGATGCTT IAGAGAGATT TTTTTTCCAT GACTGCATTI TACTGTACAG ATTGCTGCTT 1087
 CTGTATATAT TGTGATATAG CAATTAAGAG GATACACACG TTTGTTTCTT CGTGCCTGTT 1147
 TTATGTGCAC ACATTAGGCA TTGAGACTTC AAGCTTTTCT TTTTITGICC ACGIATCTIT 1207
 GGGTCTTTGA TAAAGAAAAG AATCCCTGTT CATGTGAAGC ACTTTTACGG GCGGGGTGGG 1267
 GAGGGTCTCT CTGCTGCTCT TCAATTACCA AGAATTCTCC AAAACAATIT ICTGCGAGAT 1327
 GATTGTACAG AATCATTGCT TATGACATGA TCGCTTTCTA CACTGTATTA CATAAATAAA 1387
 TTAATAAAAA TAACCCCGGG CAAGACTTTT CTTTGAAGGA TGACTIONAGA CATTAAATAA 1447
 TCGAAGTAAT TTTGGGTGGG GAGAAGAGCC AGATTCAAT TCTTTAACC AGTCTGAAGT 1507
 TTCATTTATG ATACAAAAGA AGATGAAAAT GGAAGTGGCA ATATAAGGGG ATGAGGAAGG 1567
 CAGCATG 1574

(2) INFORMATION FOR SEQ ID NO:47:

- (1) SEQUENCE CHARACTERISTICS:
 (A) LENGTH: 70 amino acids
 (B) TYPE: amino acid
 (D) TOPOLOGY: linear

(11) MOLECULE TYPE: protein

(x1) SEQUENCE DESCRIPTION: SEQ ID NO:47:

Met Leu Pro Gly Leu Ala Leu Leu Leu Leu Ala Ala Trp Thr Ala Arg
 1 5 10 15
 5 Ala Leu Glu Val Arg Thr Glu Glu Ile Ser Glu Val Lys Met Asp Ala
 20 25 30
 10 Glu Phe Arg His Asp Ser Gly Tyr Glu Val His His Gln Lys Leu Val
 35 40 45
 Phe Phe Ala Glu Asp Val Gly Ser Asn Lys Gly Ala Ile Ile Gly Leu
 50 55 60
 15 Met Val Gly Gly Val Val
 65 70

(2) INFORMATION FOR SEQ ID NO:48:

(1) SEQUENCE CHARACTERISTICS:
 (A) LENGTH: 1297 base pairs
 (B) TYPE: nucleic acid
 (C) STRANDEDNESS: single
 (D) TOPOLOGY: linear

(ii) MOLECULE TYPE: DNA (genomic)

(x1) SEQUENCE DESCRIPTION: SEQ ID NO:48:

30 GCATGCCCTGG ACAAACCCCTI CTTTAAAGAT GTGCTTCAA TTTGTATAAA ATGGTGTTTT 60
 CATGTAAATA AATACATTCT TGGAGGAGCC ACATTGTGCT GGTGTGAATG ATTCCATAGT 120
 AACAACTCTG ACCATTACT GACGTACAGA CCAGTCAGAA GTCTTCGCAT GTTGGGTACC 180
 35 CACACCTGTT GTCTCTTAAT TGCAAGTCTG AGTAGGAAGT TCGCGCCAAC ATGTGTCTCC 240
 CAGTGCTGGG AAAAATTTT ATAGACCTAA TTTACAGTCT TTACTTGATC TAAAACATTT 300
 TGCTGCCATA TTTTGGCCCT CAAGTTTGT CCAAATGAGA GACAAAGGGA AAAGTTCCAG 360
 40 GGAATAAAAA ATTAAGACAG CTGATTATCT GTAAAGCATG GTTCTCATC CTGAACGCTA 420
 CTAACATTTT GCAGGGAATA ATTCCTTGT GAAGGGAGTT GTCTGACCA GTGTAGGATA 480
 TTTATTTAAT TTATTIAIGT TTTTIGAGAC GGAGTCTCGC TCTGTACCC AGGCTGGAGT 540
 45 GCAGTGGCAC AATCTCGGCT CACTGCAAGC TCCGCTCCC GCGTTCACGC CATCTCCTC 600
 CCTCAGCCTC CTGAATAGCT GGGACTCTAG GTGCCGCCA CCACGCCCGG CIAAITTTTT 660
 50 GIATTTTTIAG TAGAGACGGG GTTTCACCGT GTTAGCCAGG ACAGTCTTCC TCTCCTGACC 720

55

TCGTGATCTG CCTGCCTCGG CCTCCCAAAG TGCTGAGATT ACAGGCCTGC AAGCCGCGCC 780
 CAGCCAGTGC TCTCCTTTTA AAAGTAGCCC ATTGGCTGGG CGCAGTGGCT CACGCCTGTA 840
 5 ATCCGAGCAC TTTGGGAGGC TCAGGCGGGT GGATCAGGAG GTCAGGAGAT CAAGAATATC 900
 CTGGCCAATA TGGTAAAACC CCATCTCTAC TAAAAIACA AAAAAAAAAA AAAAAAAAAA 960
 AAGCCCGGGC ATGGTGGCGG GCCCTTGTAG TCCCAGCTAC TCAGGAGGCT GAGGCAGGAG 1020
 10 AATGGTGTGC ACCTGGGAGG CGGAGGTTGC AGTGAGCTGA GATCGGCCCA CTGCACTCCA 1080
 GCCTGGGAGA CAGAGCGAGA CTCCTCTCA ATAAATAAAT AAATAAAIAA ATAAAAGGAG 1140
 GGCCTGGCAC GAATGACATG CAGGGAAGCC AGTGAGCAGC TGGAGGTCCC TCTACTCGTT 1200
 15 GTGTGGCCTT ATCTACCAGG CGGTTGAGTT GACGTCTTIG TGGACAGAAT TCGAGCTCGG 1260
 TACCCGGGGA TCCTCTAGAG TCGACCTGCA GGCATCC 1297

(2) INFORMATION FOR SEQ ID NO:49:

(1) SEQUENCE CHARACTERISTICS:

- (A) LENGTH: 16 base pairs
 (B) TYPE: nucleic acid
 (C) STRANDEDNESS: single
 (D) TOPOLOGY: linear

(11) MOLECULE TYPE: cDNA

(x1) SEQUENCE DESCRIPTION: SEQ ID NO:49:

AATGCCGCA TGCGGG

16

Claims

1. A minigene for expression of an amyloid precursor protein (APP) or derivatives thereof comprising
 (a) a regulatory region, said regulatory region capable of directing tissue and cell specific expres-
 40 sion,
 (b) a gene construct encoding said APP or derivative thereof, and
 (c) genetic sequences containing a RNA polyadenylation signal.
2. A minigene according to Claim 1 wherein said regulatory region further includes genetic elements
 45 conferring a developmental expression pattern of said gene construct of (b) similar to the developmen-
 tal expression pattern observed in the endogenous APP gene.
3. A minigene according to Claim 1 or 2 wherein said minigene further comprises
 (d) an intronic sequence containing acceptor and donor sites for splicing.
- 50 4. A minigene according to Claim 1 wherein said gene construct encodes APP-695, APP-751, APP-770, a
 mutated APP, a truncated APP or an A4 peptide.
5. A minigene according to Claim 1 wherein said gene construct of (b) is replaced by a reporter gene,
 55 said reporter gene capable of being monitored to assess the function of said regulatory region, or by a
 fusion protein containing a reporter gene and a gene encoding said APP or derivative thereof.
6. A minigene according to Claim 3 wherein said minigene further comprises

(e) an antigenic tag for the expression of a tagged APP or APP derivative, said tagged APP or APP derivative capable of being detected to assess said expression.

- 5
7. A minigene cassette for transfer and expression in transgenic mice of APP or derivatives thereof comprising a NotI fragment containing
- (a) a regulatory region, said regulatory region capable of directing tissue and cell specific expression.
 - (b) a gene construct encoding said APP or derivative thereof,
 - (c) genetic sequences containing a RNA polyadenylation signal, and
 - 10 (d) an intronic sequence containing acceptor and donor sites for splicing.
8. A transgenic mouse, including progeny, embryo or cell derived from said transgenic mouse, capable of expressing an amyloid precursor protein (APP) or derivatives thereof in a tissue and cell specific manner.
- 15
9. A transgenic mouse, including progeny, embryo or cell derived from said transgenic mouse, comprising a transgene for the expression of an amyloid precursor protein (APP) or derivative thereof.
10. A transgenic mouse according to Claim 9 wherein said transgene comprises a NotI minigene cassette
- 20 containing
- (a) a regulatory region, said regulatory region capable of directing tissue and cell specific expression,
 - (b) a gene construct encoding said APP or derivative thereof,
 - (c) genetic sequences containing a RNA polyadenylation signal, and
 - 25 (d) an intronic sequence containing acceptor and donor sites for splicing.
- 30
- 35
- 40
- 45
- 50
- 55

APP cDNA Sequence

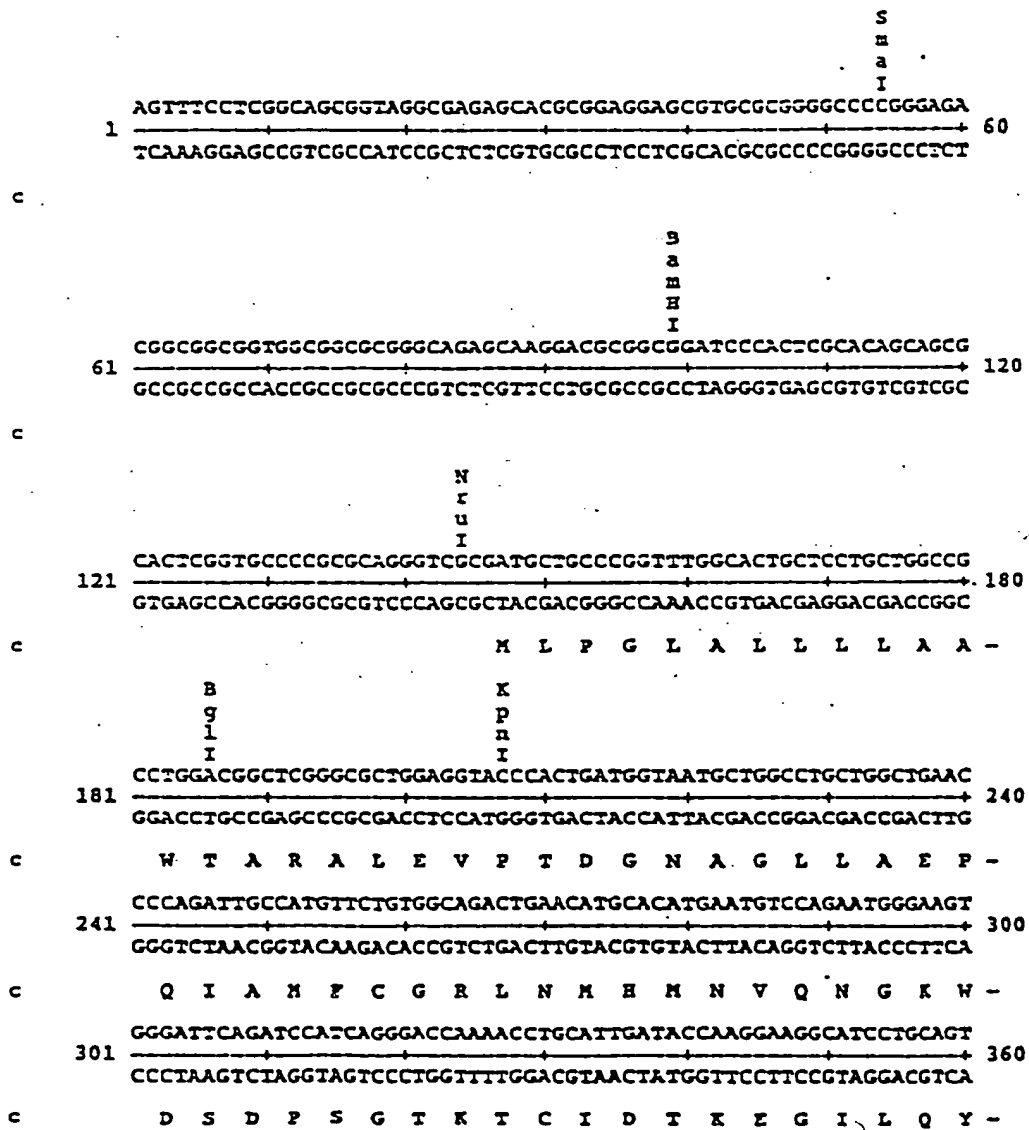


FIG. 1a

A
C
C
I

361 ATTGCCAAGAAGTCTACCCCTGAACTGCAGATCACCAATGTGGTAGAAGCCAAACCAACCAG 420
 TAACGGTTCCTCAGATGGGACTTGACGTCTAGTGGTTACACCAATCTTCGGTTGGTTGGTTC

c C Q E V Y P E L Q I T N V V E A N Q P V -

421 TGACCATCCAGAACTGGTGCAAGCGGGGGCCGCAAGCAGTGCAAGACCCATCCCCACTTTG 480
 ACTGGTAGGTCTTGACCACGTTCCGCCCGGCGTTCGTACCGTTCGGGTAGGGGTGAAAC

c T I Q N W C K R G R K Q C K T E P E F V -

481 TGATTCCTACCGCTGCTTAGTGGTGAGTTTGAAGTGATGCCCTTCCTGTTCCCTGACA 540
 ACTAAGGGATGGCGACGAATCAACCACTCAACATTCACCTACGGGAAGAGCAAGGACTGT

c I P Y R C L V G E F V S D A L L V P D K -

541 AGTGCAAAATTCCTACACCAGGAGAGSATGGATGTTTGGCAAACCTCATCTTCACCTGGCACA 600
 TCACGTTTAAGAAATGTGGTCCCTCTCTTACCTACAAACGCTTTGAGTAGAAGTGACCCGTGT

c C K F L H Q E R M D V C E T H L H W E T -

601 CCGTCGCCAAAGAGACATGCAGTGAGAAGAGTACCAACTTGCATGACTACGGCATGTTGC 660
 GCGACGGGTTCTCTGTACGTCACTCTTCTCATGGTTGAACGZACTGATGCCGTACAACG

c V A K E T C S E K S T N L E D Y G H L L -

661 TGCCCTGGCGAATTGACAAGTTCGGAGGGGTAGAGTTTGTGTGTTGCCACTGGCTGAAG 720
 ACGGGACGGCTTAACGTGTTCAAGGCTCCCCATCTCAAACACACAACGGGTGACCGACTTC

c P C G I D K F R G V E F V C C P L A E E -

721 AAAGTGACAATGTGGATTCCTGCTGATGCGGAGGAGGATGACTCGGATGTCCTGGTGGGGCG 780
 TTCACCTGTACACCTAAGACGACTACGCTCTCTCTTACTGAGCCTACAGACCACCCCGC

c S D N V D S A D A E E D D S D V W W G G -

781 GAGCAGACACAGACTATGCAGATGGGAGTGAAGACAAAGTAGTAGAAGTAGCAGAGGAGG 840
 CTCGTCTGTGTCGTATACGTCTACCCCTCACTTCGTTTCATCATCTTCACTCGTCTCTCC

c A D T D Y A D G S E D K V V E V A E E E -

841 AAGAAGTGGCTGAGGTGGAAGAAGAAGACCCGATGATGACGAGGACGATGAGGATGGTG 900
 TTCCTCACCGACTCCACCTTCTTCTTCTTGGGCTACTACTGCTCCTGCTACTCTACCAC

c E V A E V E E E E A D D D E D D E D G D -

901 ATGAGGTAGAGGAAGAGGCTGAGGAACCCCTACGAAGAAGCCACAGAGAGAACCACCAGCA 960
 TACTCCATCTCCTTCTCCGACTCCTTGGGATGCTTCTTCGGTGTCTCTCTGGTGGTGGT

c E V E E E A E E P Y E E A T E R T T S I -

961 TTGCCACCACCACCACCACCACAGAGTCTGTGGAAGAGGTTGGTTCGAGTTCCTACAA 1020

FIG.1b

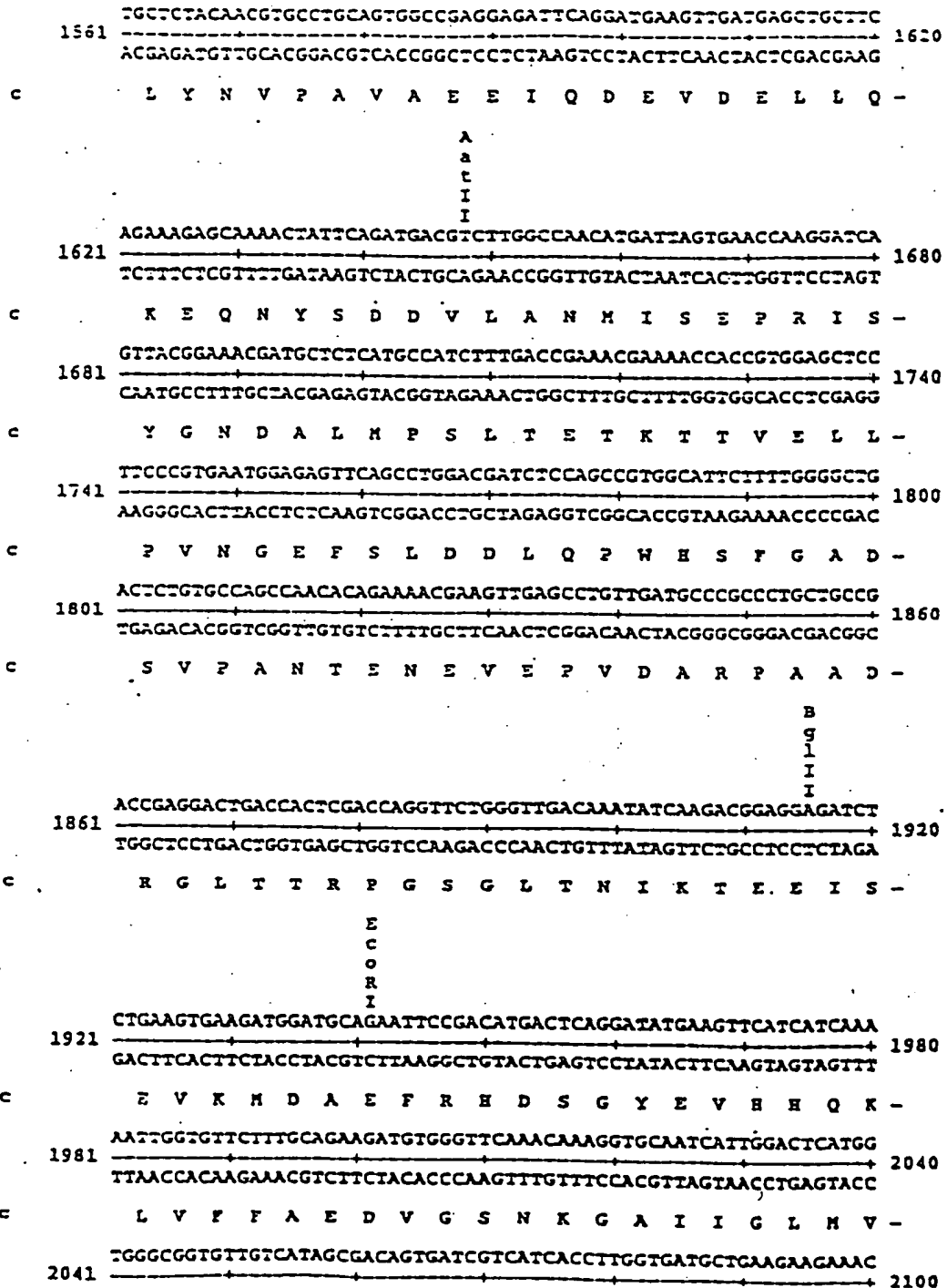


FIG.1d

ACCCCCCACAACAGTATCGCTGTCACTAGCAGTAGTGGAAACCCTACGACTTCTTCTTTG
 c G G V V I A T V I V I T L V N L K K K Q -
 2101 AGTACACATCCATTTCATCATGGTGTGGTGGAGGTTGACGCCGCTGTCACCCCAGAGGAGC 2160
 TCATGTGTAGGTAAGTAGTACCACACCACCTCCAACCTCGCGCGACAGTGGGGTCTCTCTCG
 c Y T S I H H G V V E V D A A V T P E E R -
 2161 GCCACCTGTCCAAGATGCAGCAGAACGGCTACGAAAATCCAACCTACAAGTCTTTGAGC 2220
 CGGTGGACAGGTTCTACGTCGTCTTGCCGATGCTTTTAGGTTGGATGTTCAAGAAACTCG
 c H L S K M Q Q N G Y E N P T Y K F F E Q -
 2221 AGATGCAGAACTAGACCCCGCCACAGCAGCCTCTGAAGTTGGACAGCAAACCATTTGCT 2280
 TCTACGTCCTTGATCTGGGGCGGTGTCGTCCGAGACTTCAACCTGTCTTTGGTAACGA
 c M Q N *
 2281 TCACTACCCATCGGTGTCCATTTATAGAATAATGTGGGAAGAAAACAAACCCGTTTATGA 2340
 AGTGATGGGTAGCCACAGGTAAATATCTTATTACACCCTTCTTTGTTGGGCAAAATACT
 c
 2341 TTTACTCATTATCGCCTTTTGACAGCTGTGCTGTAACACAAGTAGATGCCCTGAACCTGAA 2400
 AAATGAGTAATAGCGGAAAACGTGCGACACGACATTGTGTTTCATCTACGGACTTGAACCT
 c
 2401 TTAATCCACACATCAGTAATGIATTCTATCTCTCTTTACATTTTGGTCTCTATACTACAT 2460
 AATTAGGTGTGTAGTCATTACATAAGATAGAGAGAAATGTAAAACAGAGATATGATGTA
 c
 2461 TATAATGGGTTTTGTGACTGTAAAGAATTTAGCTGIATCAAACIAGTGCATGAATAGA 2520
 AATAATTACCCAAAACACATGACATTTCTTAAATCGACATAGTTTGATCACGTAATCTT
 c
 2521 TTCTCTCCTGATTATTATCACATAGCCCTTAGCCAGTTGTATATTCTTGTGGTTT 2580
 AAGAGAGGACTAATAAATAGTGATCGGGGAATCGGTCAACATAATAAGAACACAAA
 c
 N C
 d l
 e a
 I I
 2581 GTGACCCAAATTAAGTCTACTTTACATATGCTTTAAGAATCGATGGGGGATGCTTCATGT 2640
 CACTGGGTAAATCAGGATGAAATGTATACGAAATCTTAGCTACCCCTACGAAGTACA

FIG: 1e

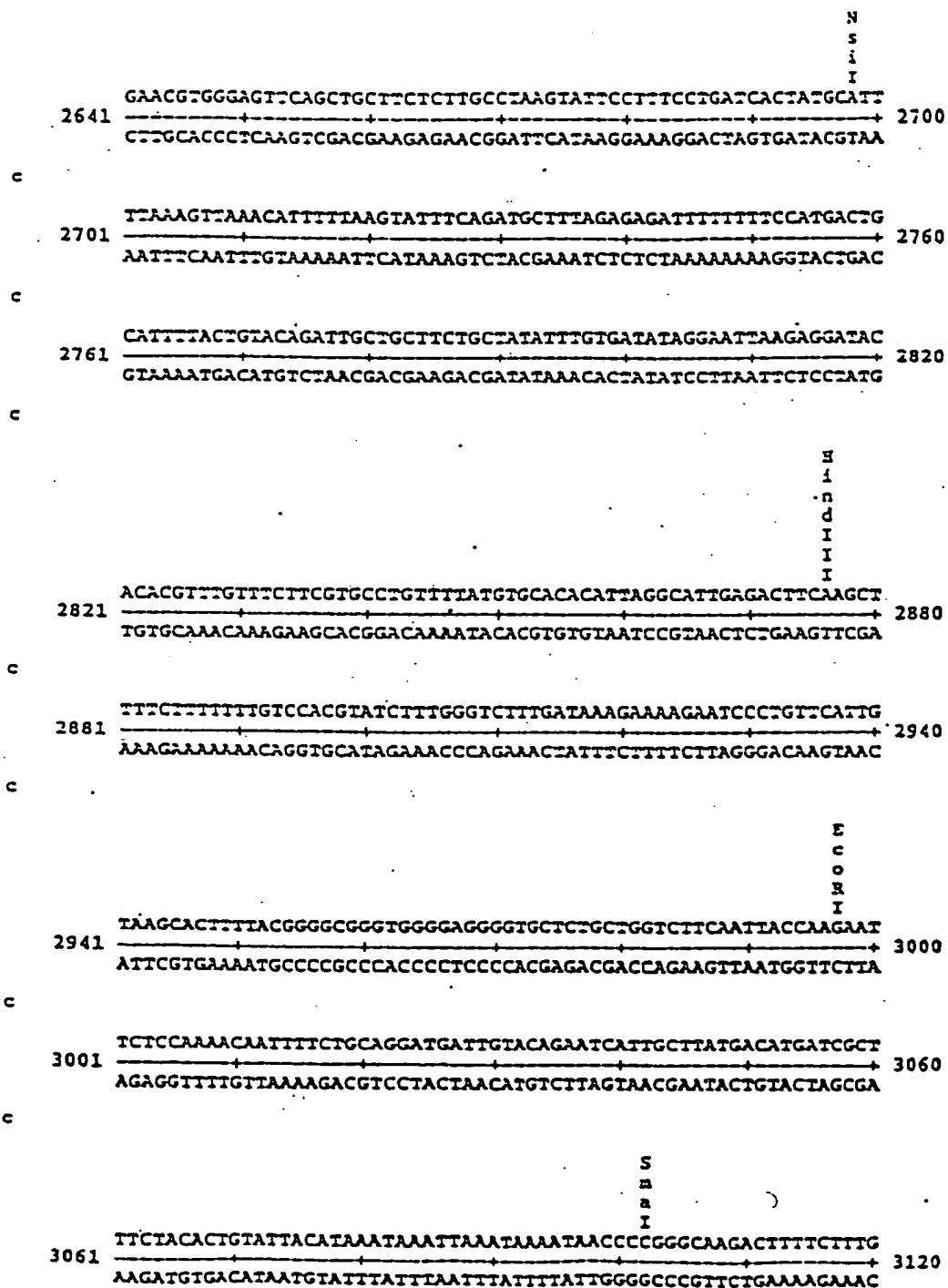


FIG. 1f

c
3121 AAGGATGACTACAGACATTAATAATCGAAGTAATTTGGGTGGGGAGAAGAGGCAGATT 3180
TCCCTACTGATGTCGTGAATTTATTAGCTTCATTAACCACCCCTCTTCTCCGTCTAA

c
3181 CAATTTCTTTAACCAGTCTGAAGTTTCATTTATGATACAAAAGAAGATGAAAATGGAAG 3240
GTTAAAAGAAATTGGTCAGACTTCAAAGTAAATACTATGTTTTCTTACTTTTACCTTC

c
3241 TGGCAATATAAGGGGATGAGGAAGGCATGCCCTGGACAAACCCCTCTTTAAGATGTGTCT 3300
ACCGTTATATCCCTACTCCTCCGTACGGACCTGTTGGGAAGAAAATTCACACAGA

c
3301 TCAATTTGTATAAAATGGTGTTTTCATGTAAATAAATACATTCTTGGAGGAGC 3353
AGTAAACATATTTACCACAAAAGTACATTTATTATGTAAGAACCTCCTCG

S
P
h
I

FIG.1g

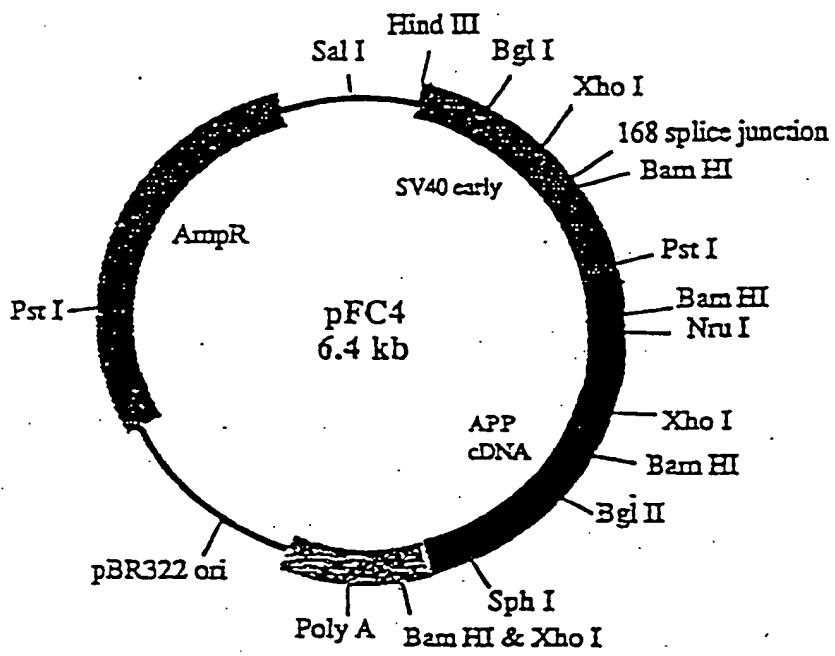


FIG. 2

β - AMYLOID PLAQUE PRECURSOR (APP) GENE; 5' END

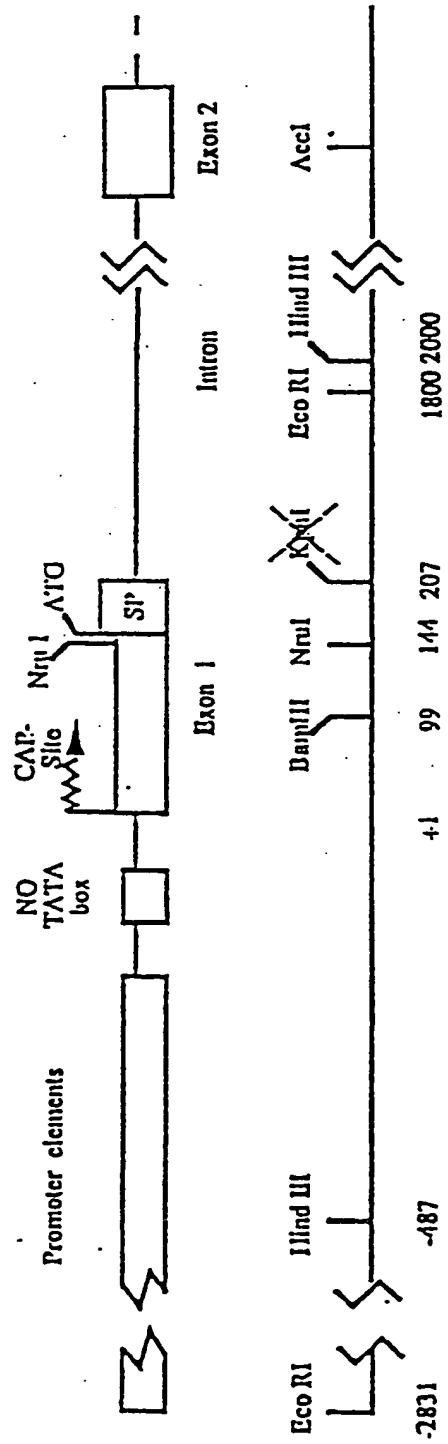
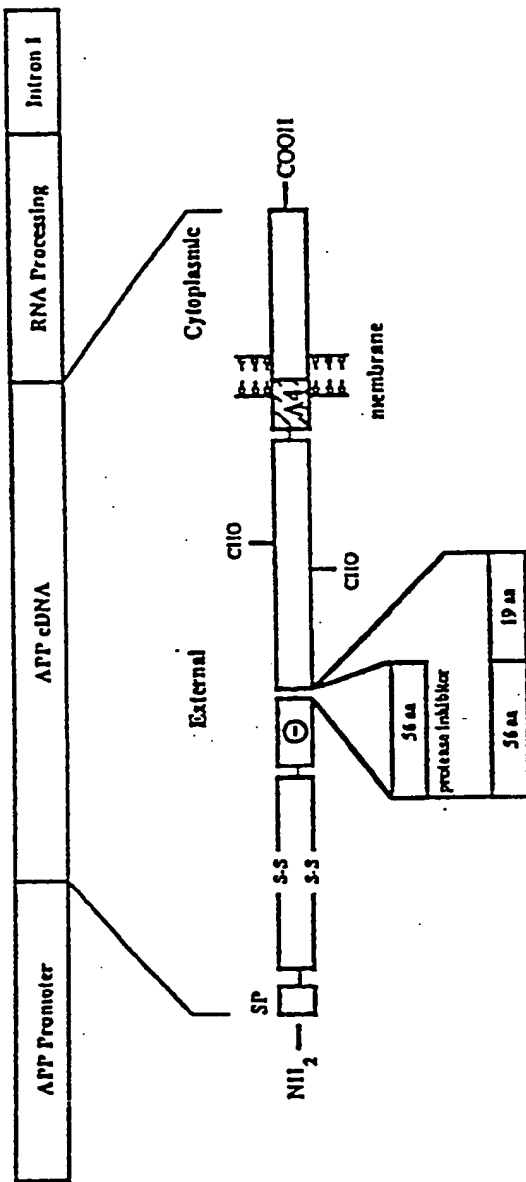


FIG. 3

APP MINIGENE SERIES



Gene Products

I. (695 aa.)

II. (751aa.)

III. (770 aa.)

FIG. 4a

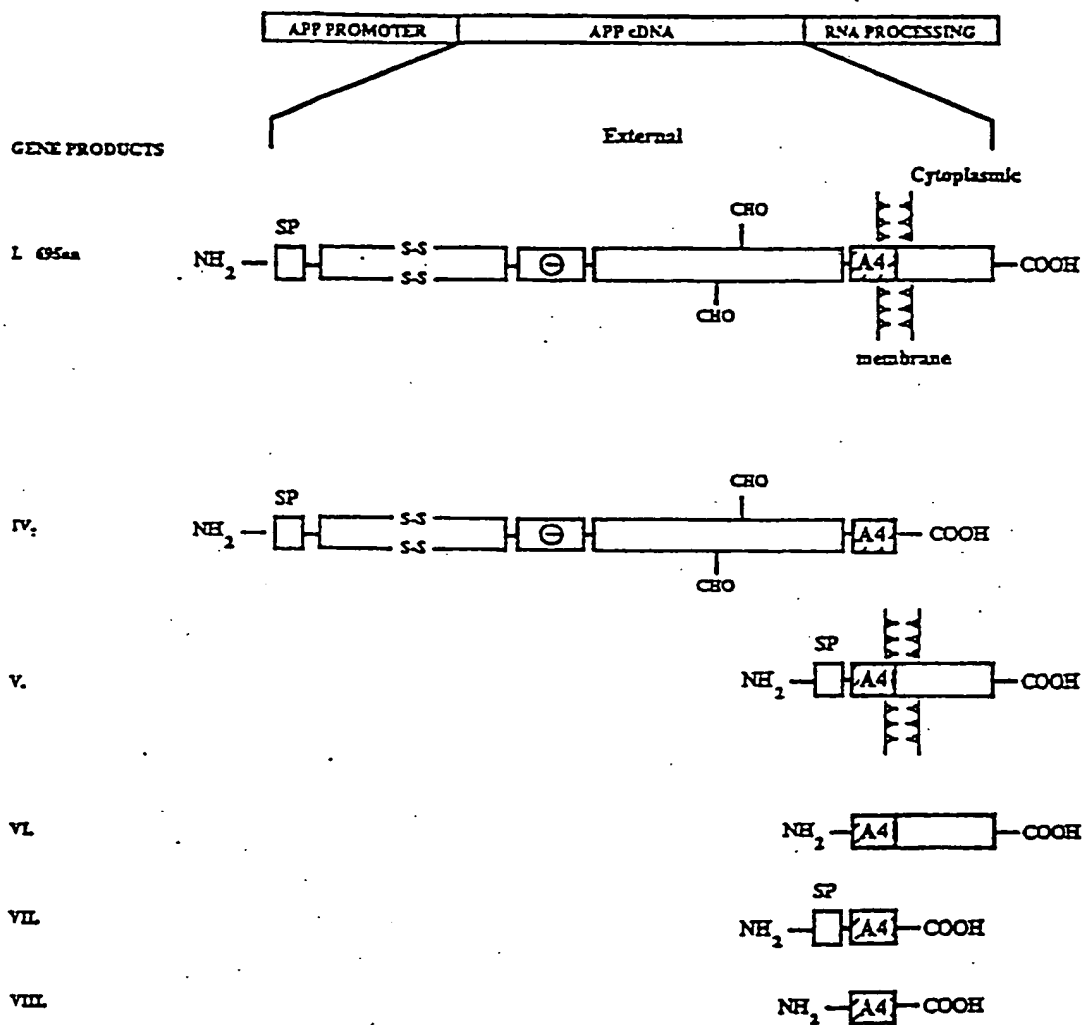


FIG. 4b

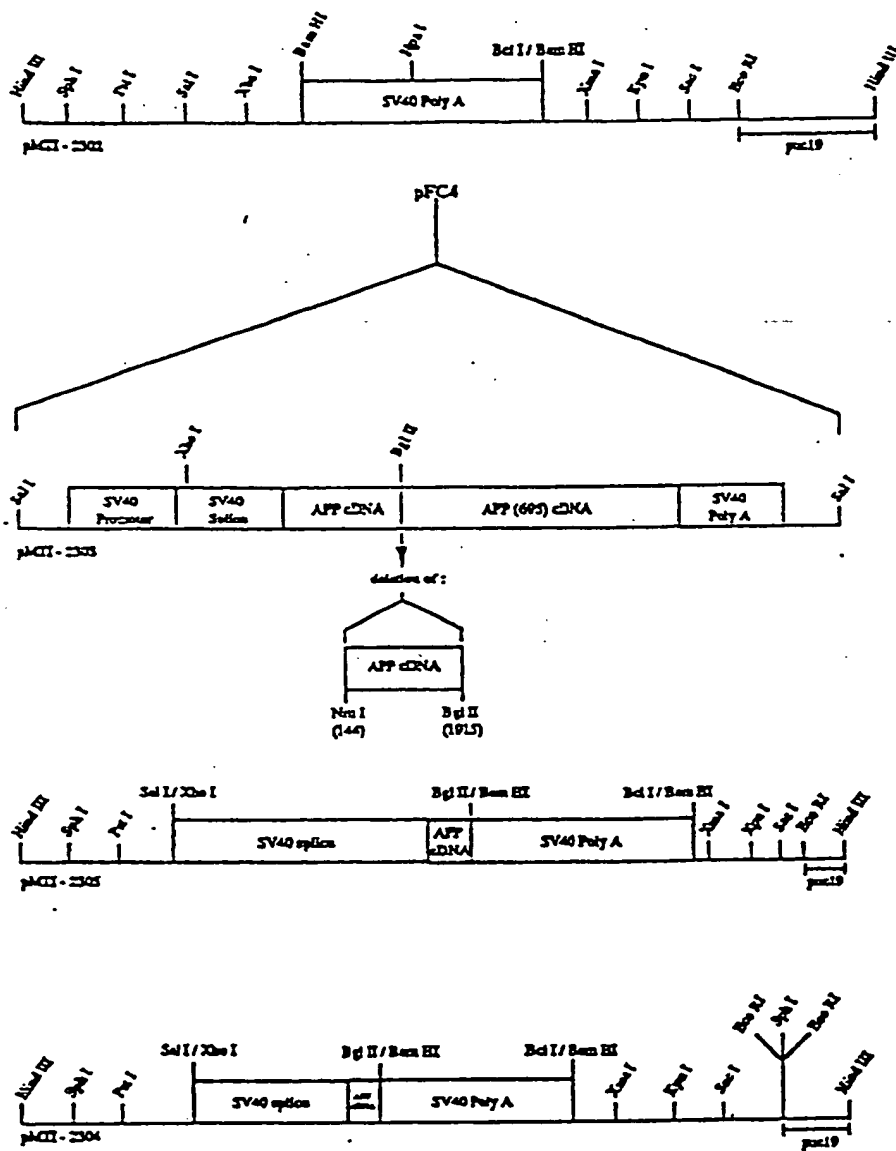
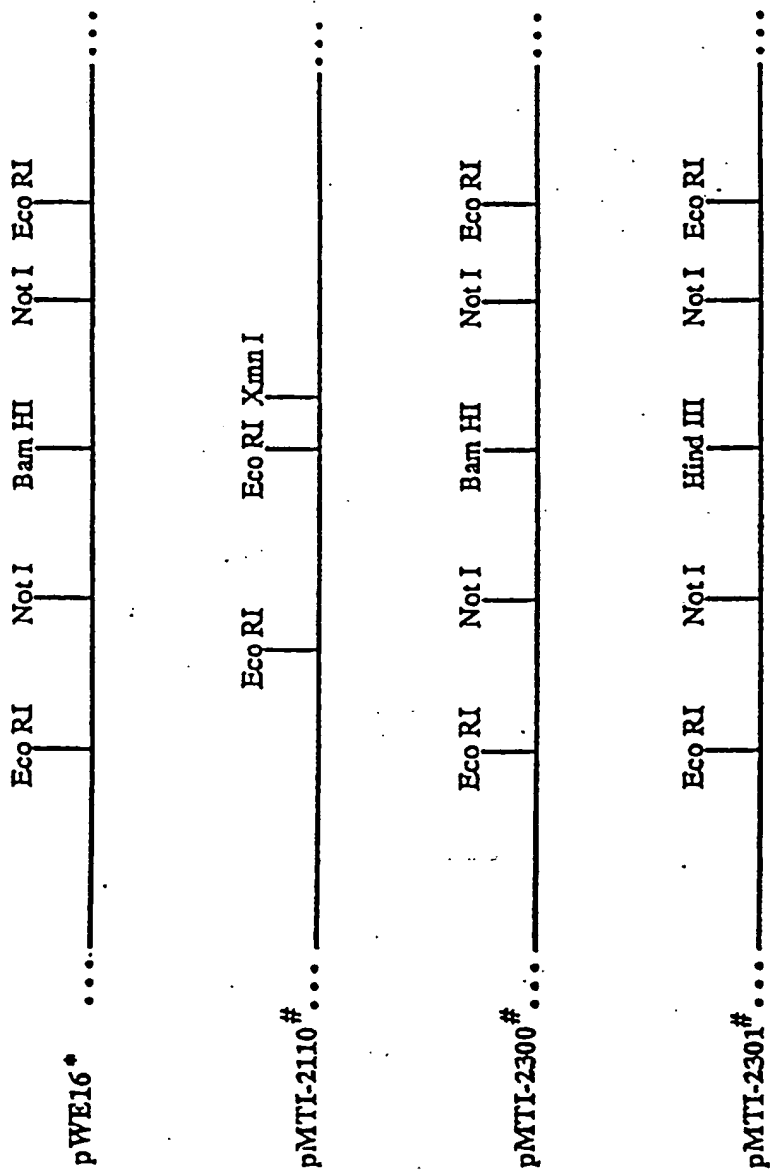


FIG. 5



* polylinker region of pWE16

polylinker region: puc19 vector sequence not shown

FIG. 6a

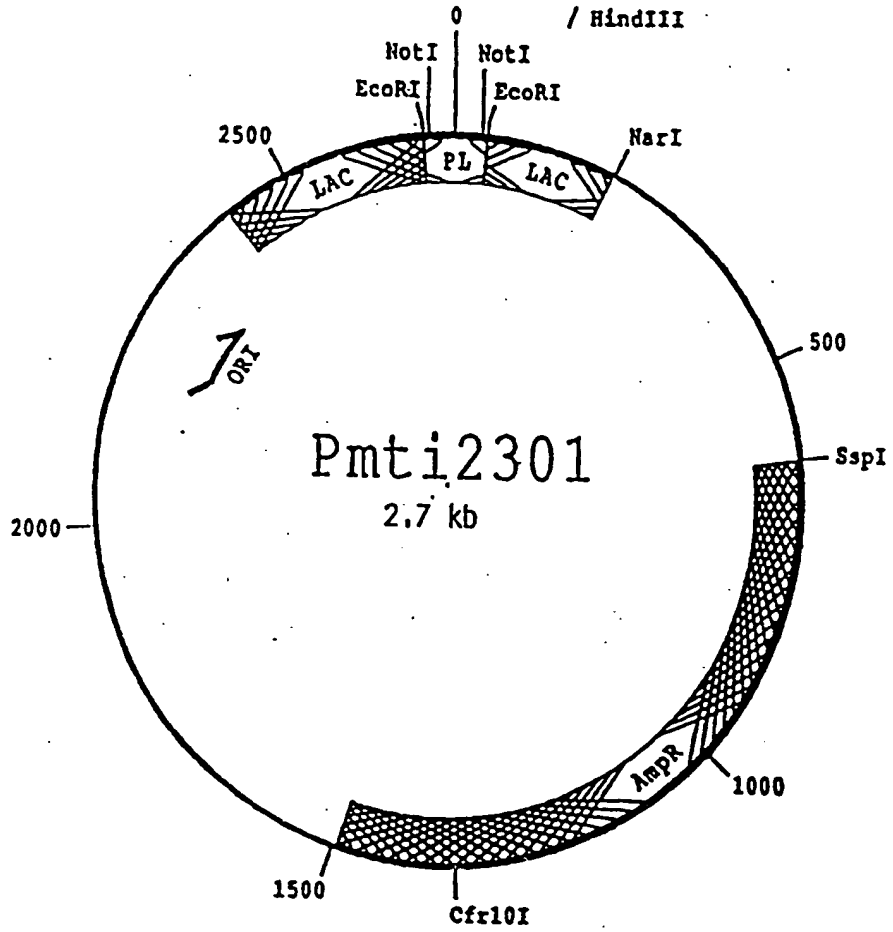


FIG. 6b

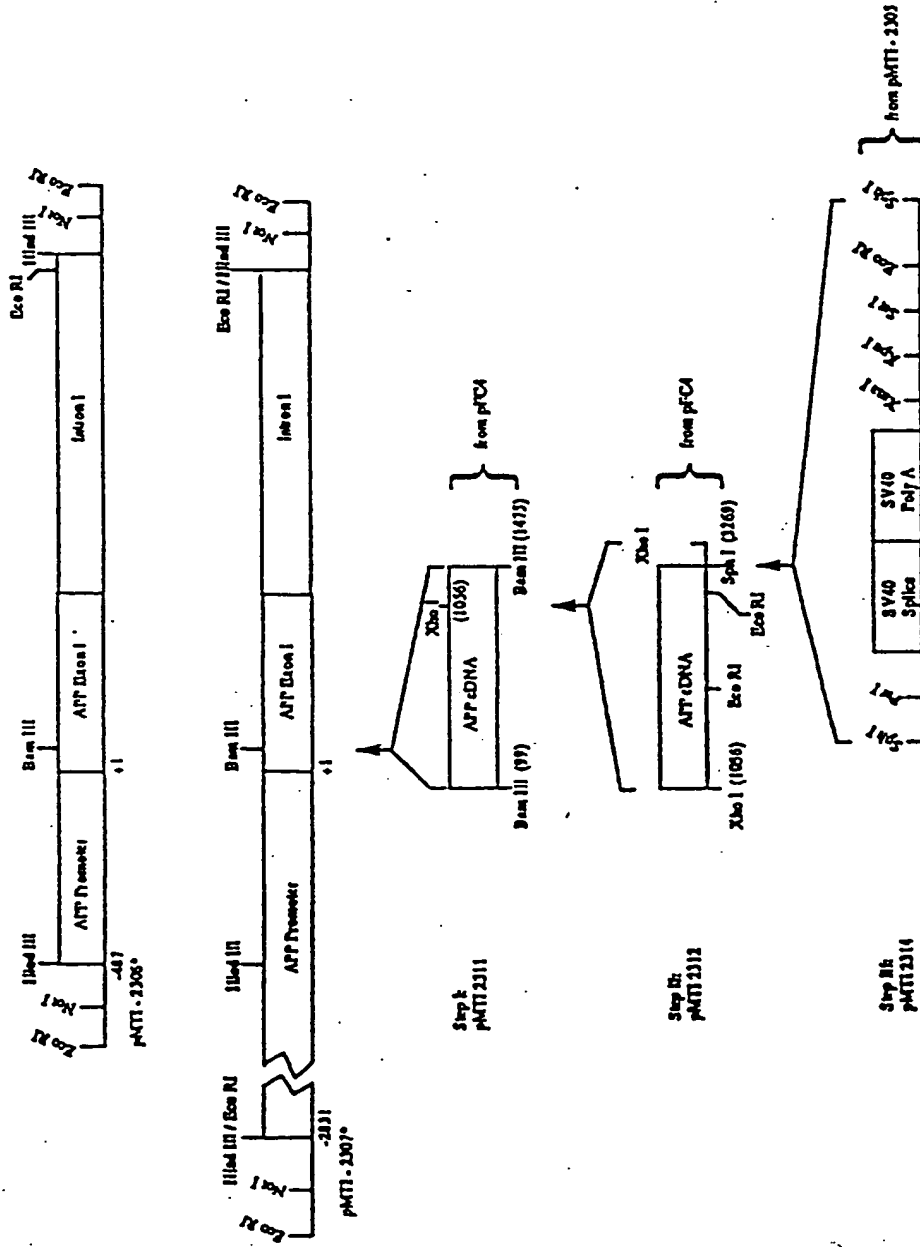


FIG. 7a

*restriction sequences not shown

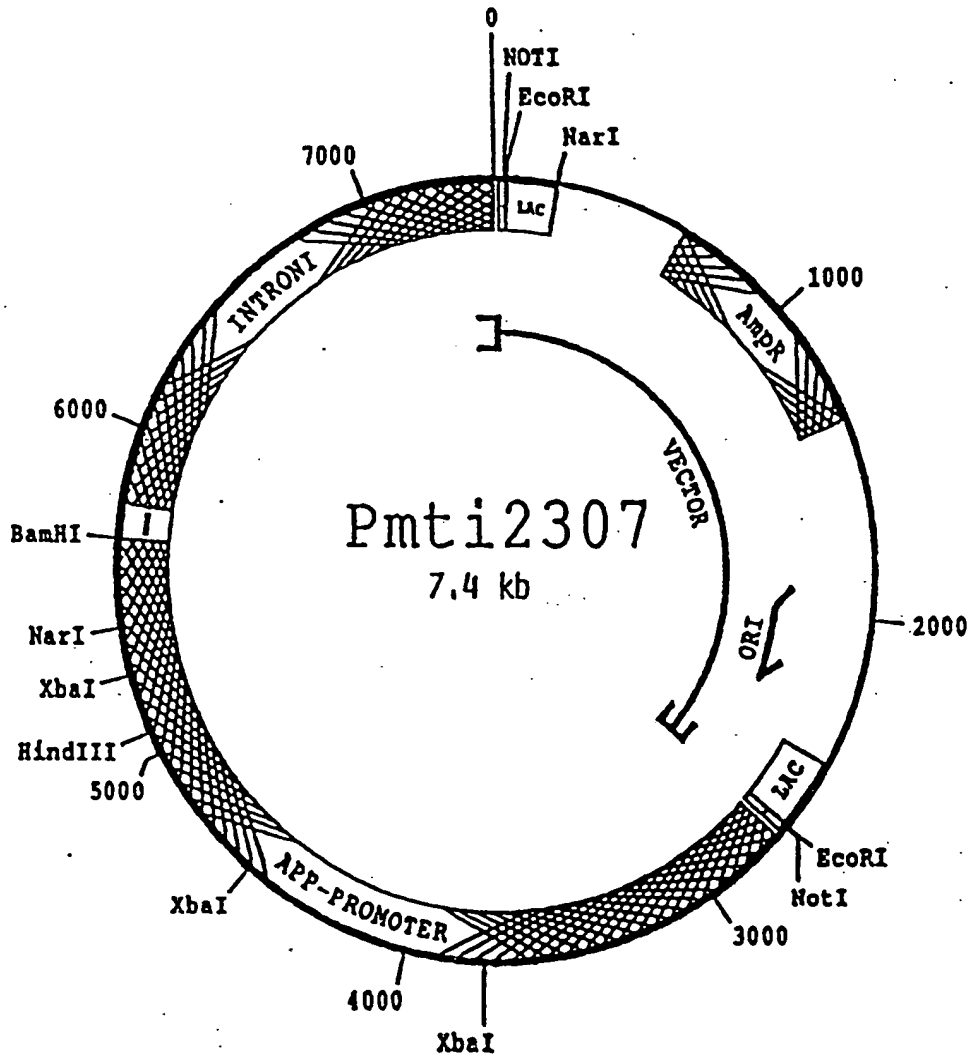


FIG.7b

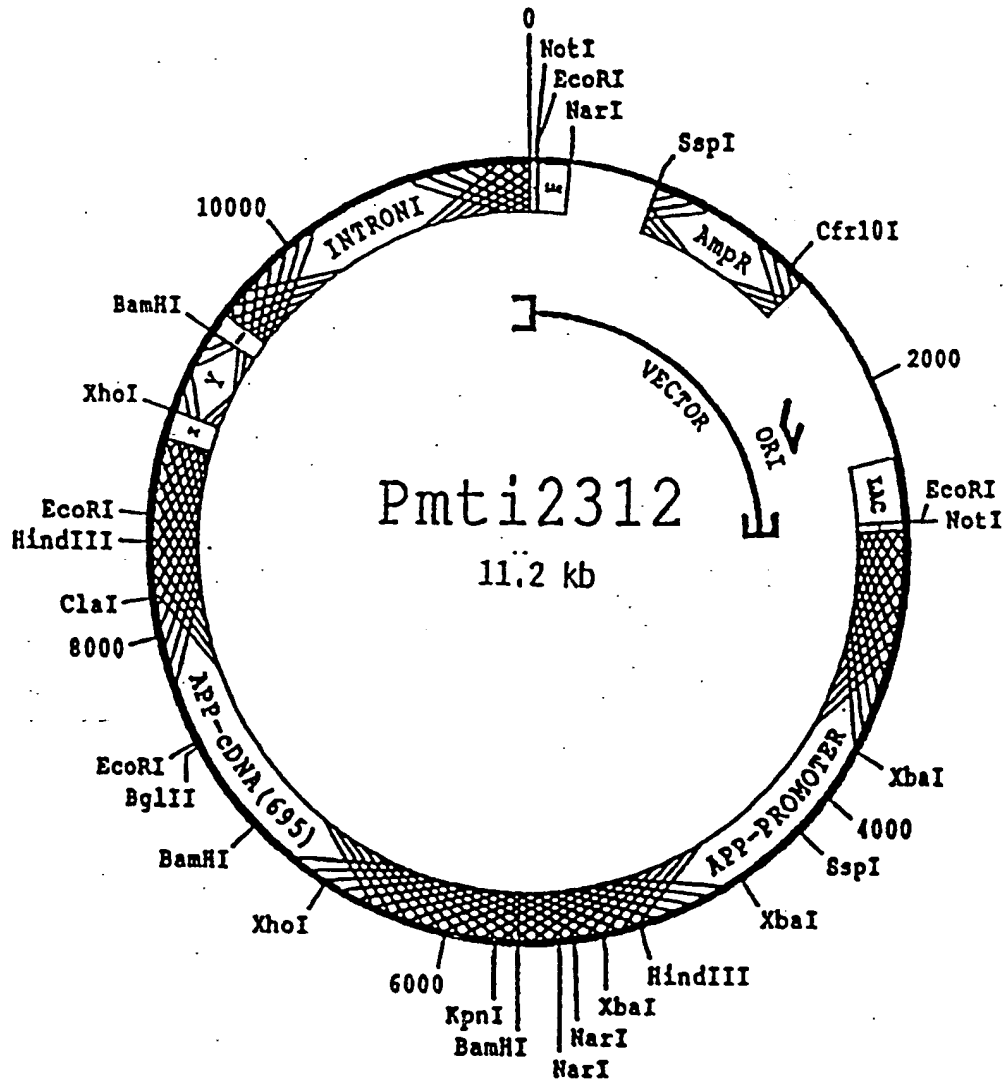


FIG.7c

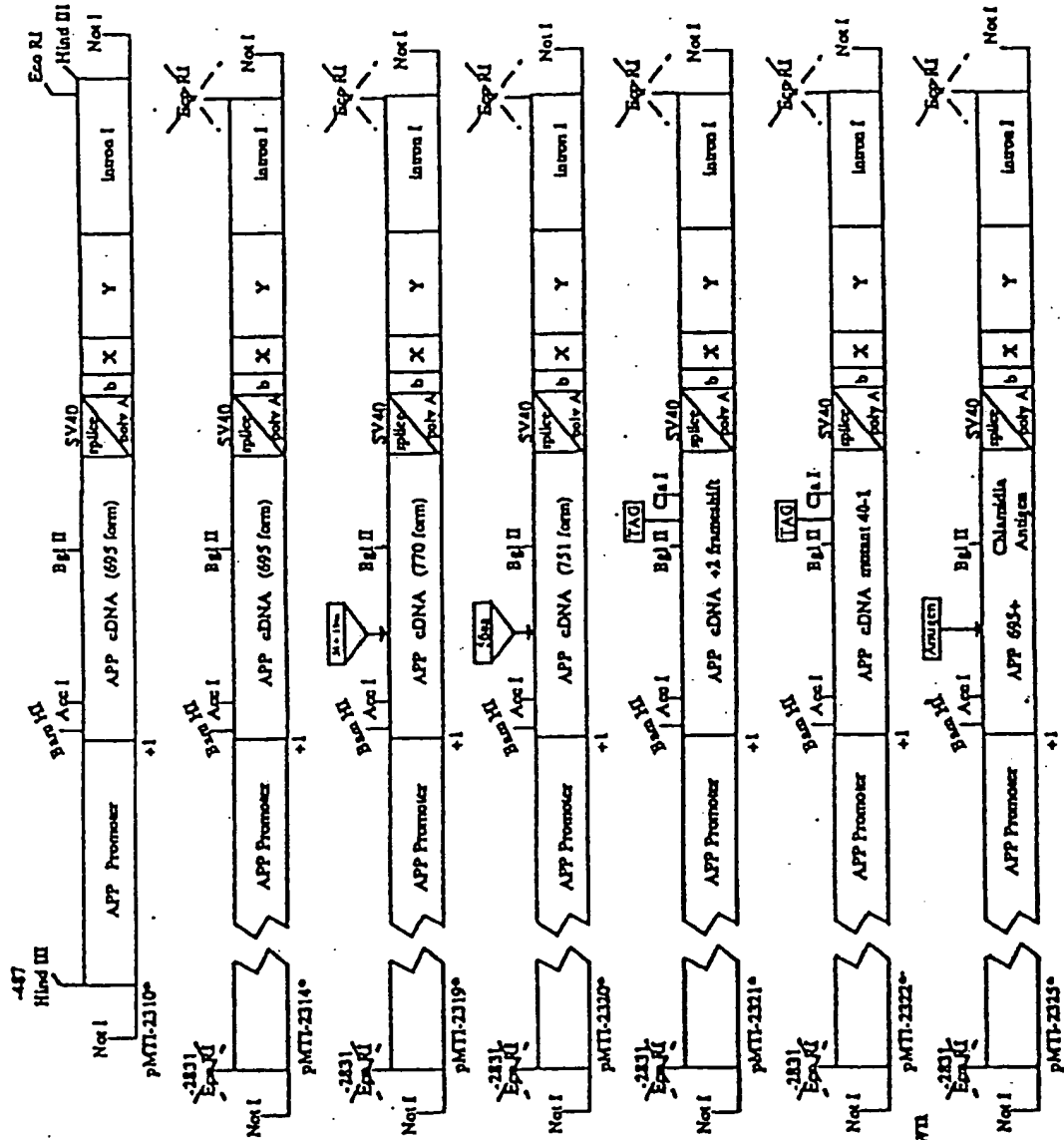


FIG. 8 a

* vector sequences not shown

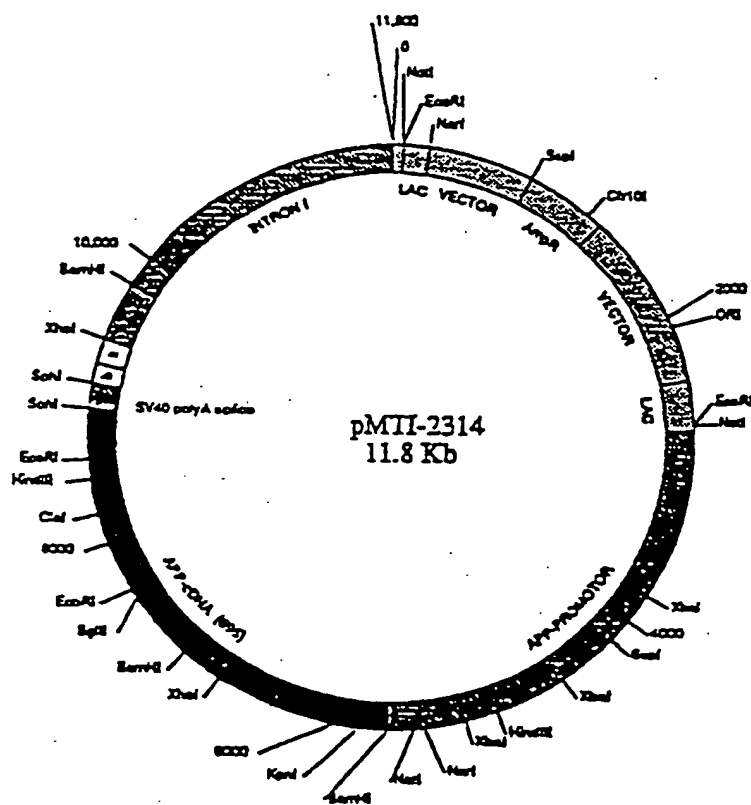


FIG. 8b

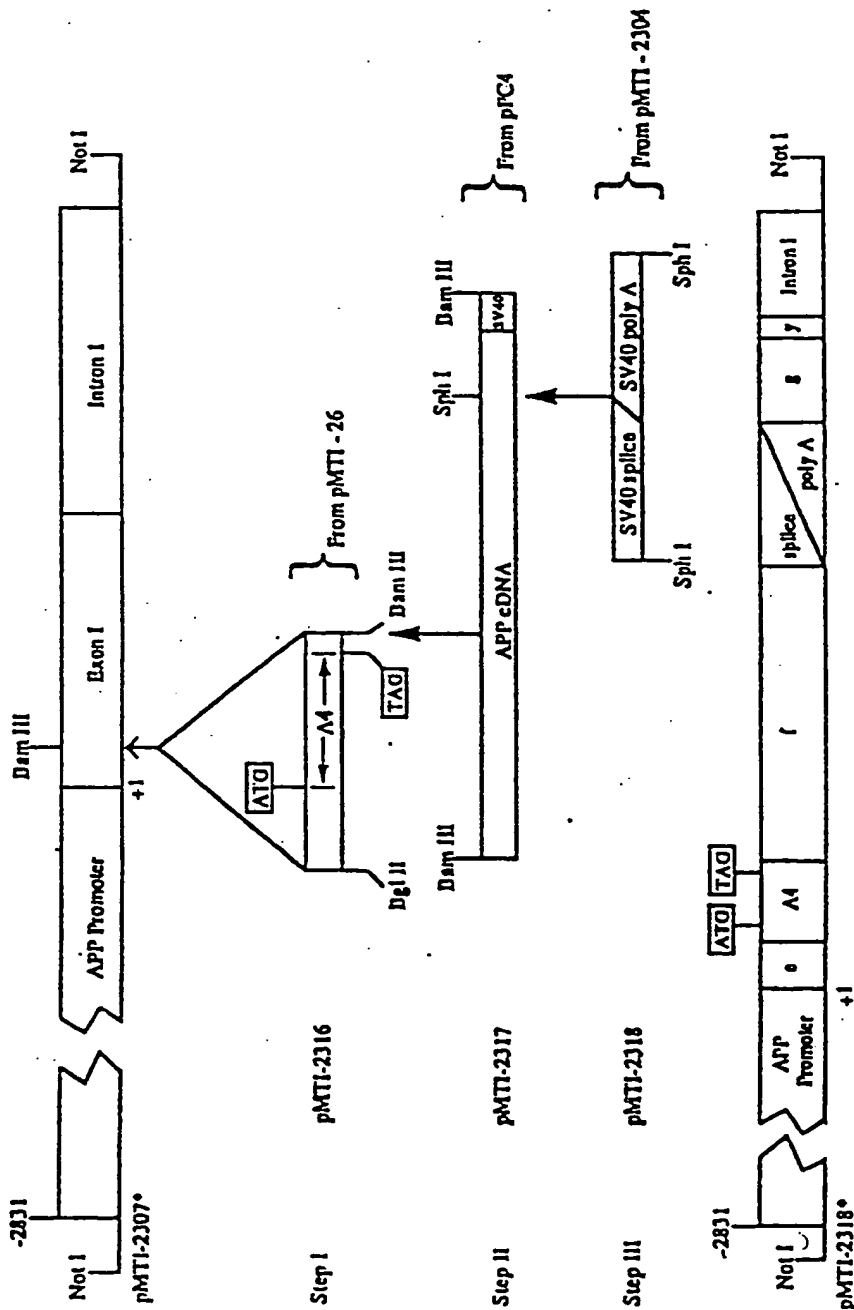
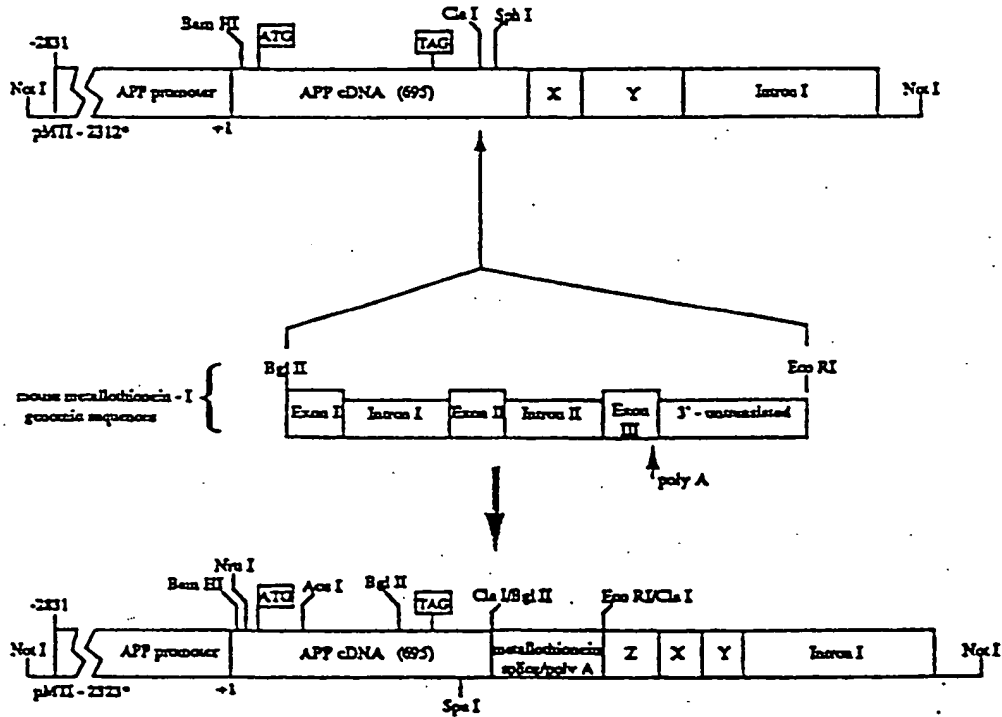


FIG.9

* vector sequences not shown



Alternate Forms:

- pMTI - 2331: exchange of Aca I - BglII fragment from pMTI - 3521 to pMTI - 2323.
- pMTI - 2332: exchange of Aca I - BglII fragment from pMTI - 3524 to pMTI - 2323.
- pMTI - 2324: exchange of Aca I - BglII fragment from pMTI - 35 to pMTI - 2323.
- pMTI - 2326: exchange of BglII - SpeI fragment from pMTI - 2322 to pMTI - 2323.

*vector sequences not shown

FIG. 10a

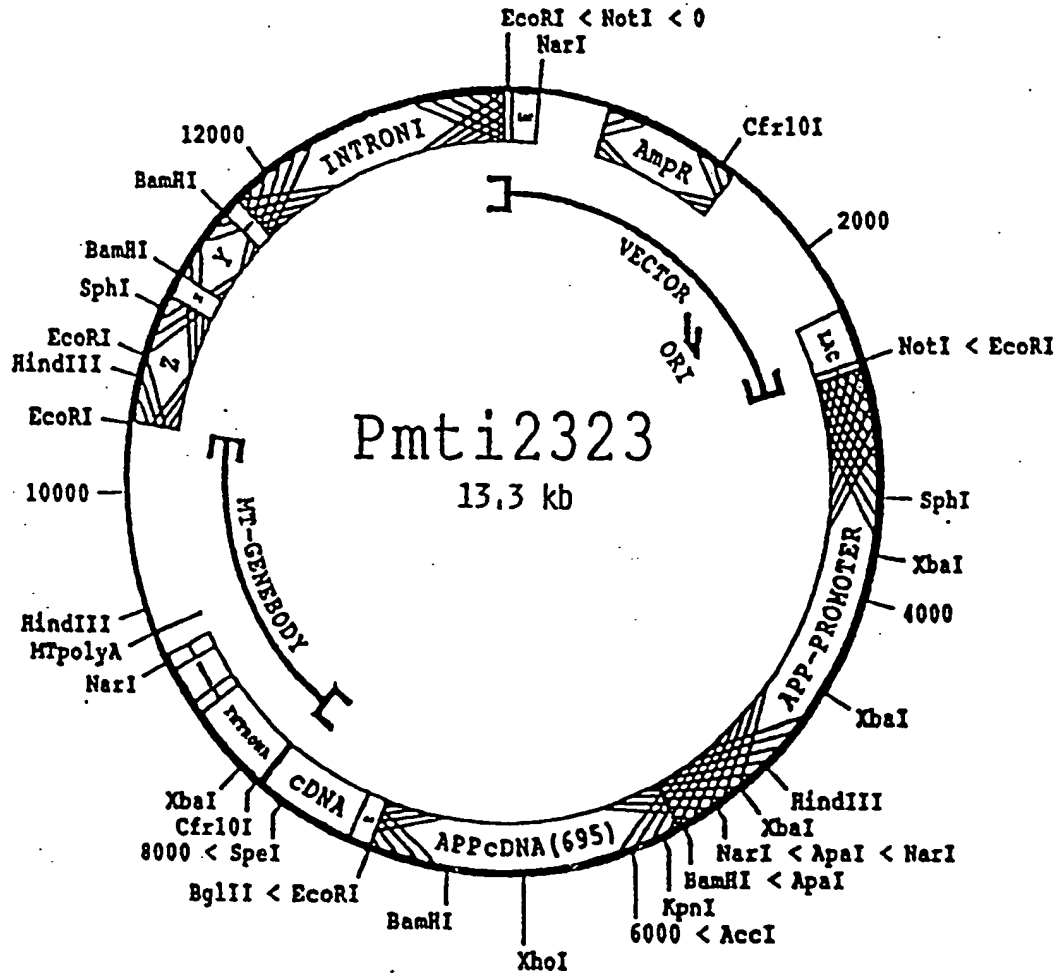


FIG.10b

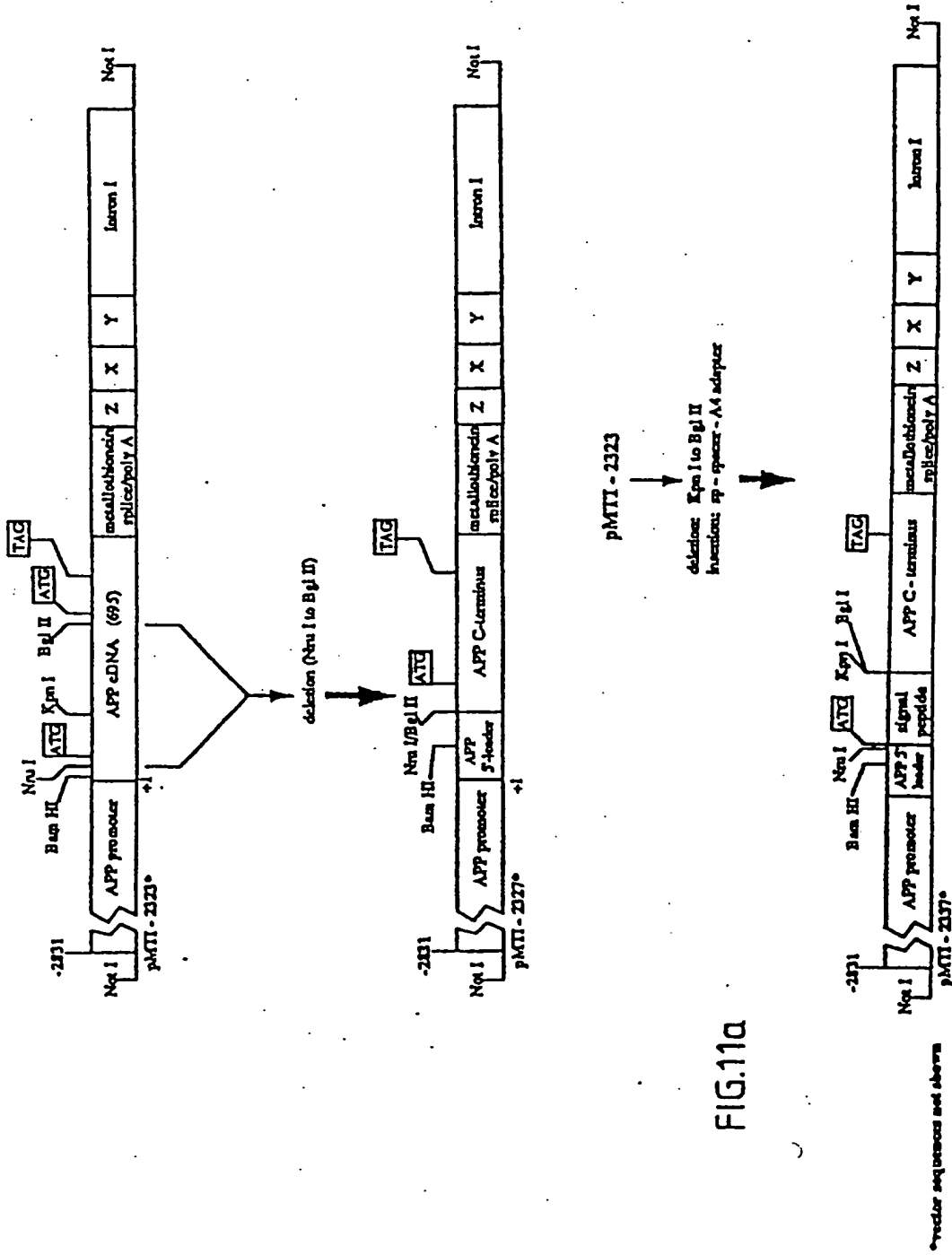


FIG.11a

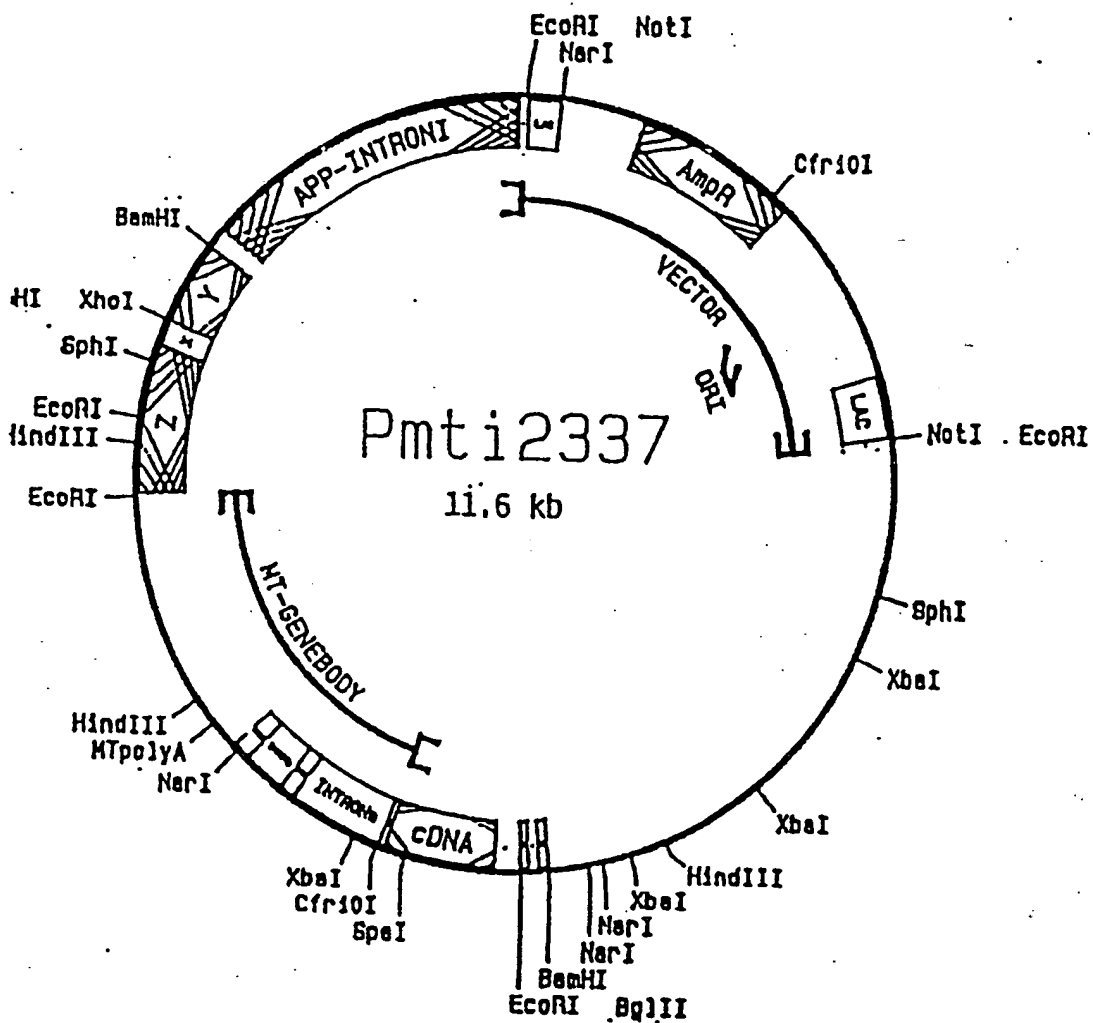


FIG.11b

A

sp - spacer - A4:

KpnI EglII

5' - ggacggagga - 3' 10mer

3' - catgcttgcctccctcag - 5' 18mer

B

MC-100:
DNA/Ambio Add
Sequences

```

      10              30              50
AGTTTCCTCGGCAGCGGTAGGCGAGAGCACGCGGAGGAGCGTGCGCGGGGCCCCGGGAG

      70              90              110
ACGGCGCGGCTGGCGGCGGGGCAGAGCAAGGACGGCGGGATCCCACCTCGCACAGCAGC

      130              150              170
GCACTCGGTGCCCCGGCGAGGGTCCGCATGCTGCCCGGTTTGGCACITGCCTCTGCTGGCC
      M L P G L A L L L L A

      190              230
GCCCGGACGGCTCGGGCGCTGGAGGACGGACGGAGGAGATCTCTGAAGTGAAGATGAT
A W T A R A L E V R T E E I S E V K M D
      SP  [ sp-spacer-A4 ] A4

      250              270              290
GCAGAAATCCGACATGACTCAGGATAIAGAAGTTCATCATCAAAAATGGTGTCTTTGCA
A E F R H D S G Y E V H H Q K L V F F A

      310              330              350
GAAGATGTGGGTTCAAACAAGGTGCATCATTTGGACTCATGGTGGCGGGTGTGTGTA
E D V G S N K G A I I G L M V G G V V I

      370              390              410
GCGACAGTGATCGTCATCACCTTGGTGAIGCTGAAGAGAAACAGTACACATCCATTCA
A T V I V I T L V M L K K K Q Y T S I H

      430              450              470
CATGGTGTGGTGGAGGTTGACCGCGCTGTGACCCAGAGGAGCGCCACCTGTCCAAGATG
H G V V E V D A A V T P E E R H L S K H

      490              510              530
CAGCAGACGGCTACGAAAATCCAACCTACAAGTTCCTTTGAGCAGATGCAGAACIAGACC
Q Q N G Y E N P T Y K F F E Q H Q N

      550              923              1572
CCCCCACAGCAGC <<-----|-----|----->>
                   |           |
                   Cla I     Sph I
                   (and MII-2337) (MII-2343)
    
```

FIG.12

A.
sp - spacer - A4:

KpnI BglIII

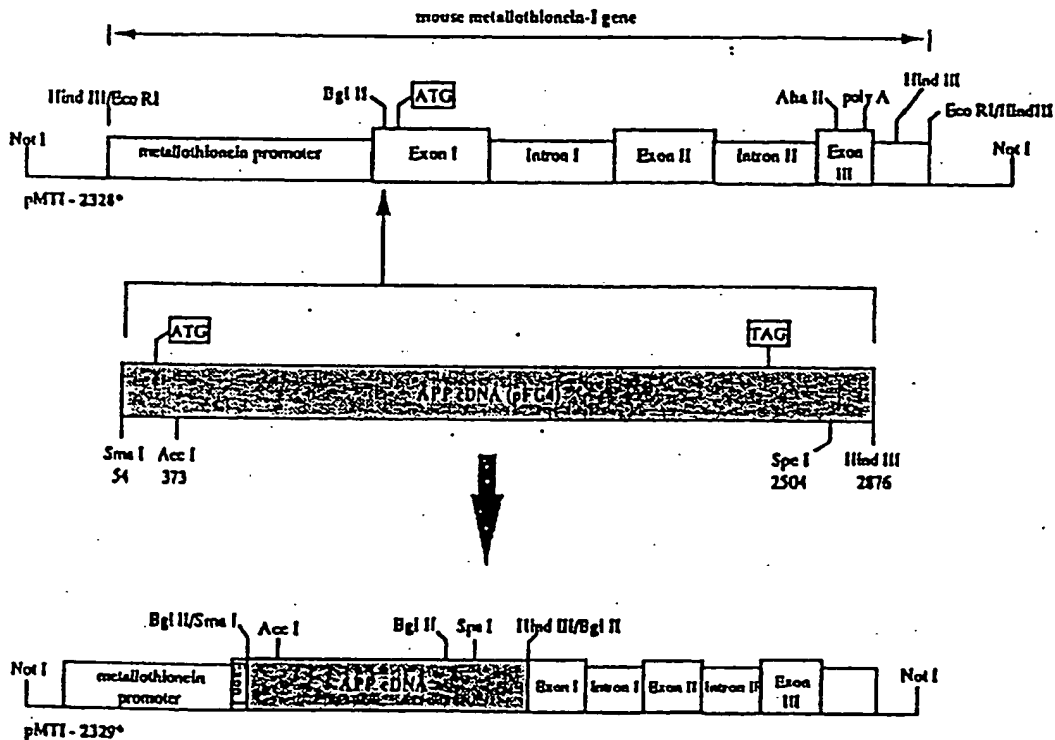
5' - ggacggagga - 3' 10mer

3' - catgcctgcctcctctag - 5' 18mer

B.
sp-A4:
DNA/Amino Acid Sequences

10	30	50
AGTTTCCTCGGCAGCGGTAGGCGAGAGCACGCGGAGGAGCGTGCCGCGGGGGCCCGGGAG		
70	90	110
ACGGCGGGGTGGCGGCGGGSCAGAGCAAGGACGCGGGCGGATCCCACTCGCACAGCAGC		
130	150	150
GCACTCGGTGCCCCCGGCAGGGTCGGGATGCTGCCCGGTTTGGCACTGCTCCTGCTGGCC		
	M L P G L A L L L L A	
190	230	
GCCTGGACGGCTCGGGCGCTGGAGGATCggacggaggaGATCTCGAAGTGAAGATGAT		
A W T A R A L E V	R T E E I S E V K H D	
250	270	290
GCAGAATTCGGACATGACTCAGGATATGAAGTTCATCATCAAAAATTGGTGTTCITTGCA		
A E F R H D S G Y E V H H Q K L V F F A		
310	330	350
GAAGATGTGGGTTCAAACAAGGTGCAATCATTGGACTCATGGTGGGCGGTTGTCTIAG		
E D V G S N K G A I I G L H V G G V V		
CGACAGTGATCGTTCATCACCTTGGTGTGCTGAAGAAGAAACAGTACACATCCATTCATC		
430	922	1371
ATGGTGTGGT		
	Cla I	Sph I
	(end pMTI-2341)	(pMTI-2344)

FIG.13

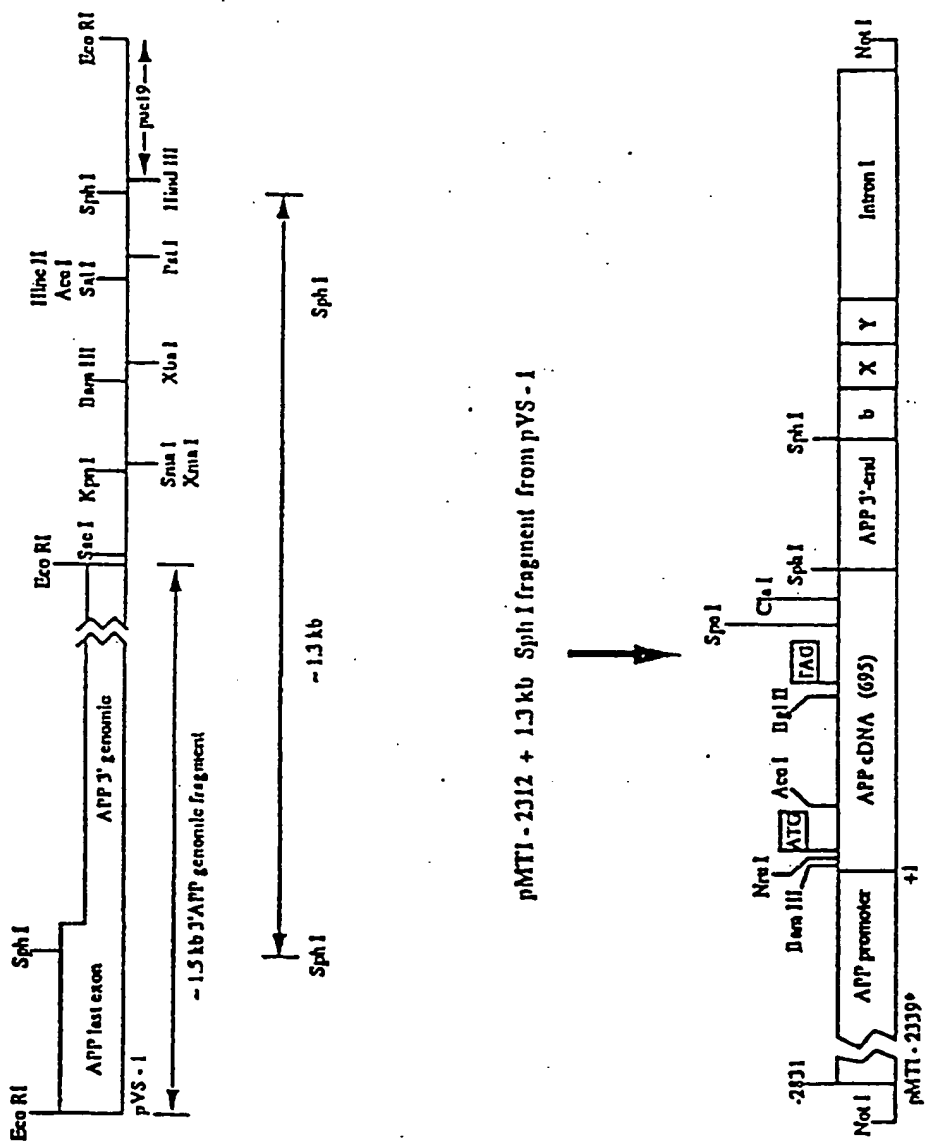


Alternate Forms:

- pMTI - 2333: exchange of AccI - SpeI fragment from pMTI - 3521 to pMTI - 2329.
- pMTI - 2334: exchange of AccI - SpeI fragment from pMTI - 3524 to pMTI - 2329.
- pMTI - 2335: exchange of AccI - SpeI fragment from pMTI - 35 to pMTI - 2329.
- pMTI - 2336: exchange of BglII - SpeI fragment from pMTI - 2322 to pMTI - 2329.

*restriction sequences not shown

FIG. 14



pMT1 - 2312 + 1.3 kb Sph I fragment from pYS - 1

FIG. 15a

*vector sequences not shown

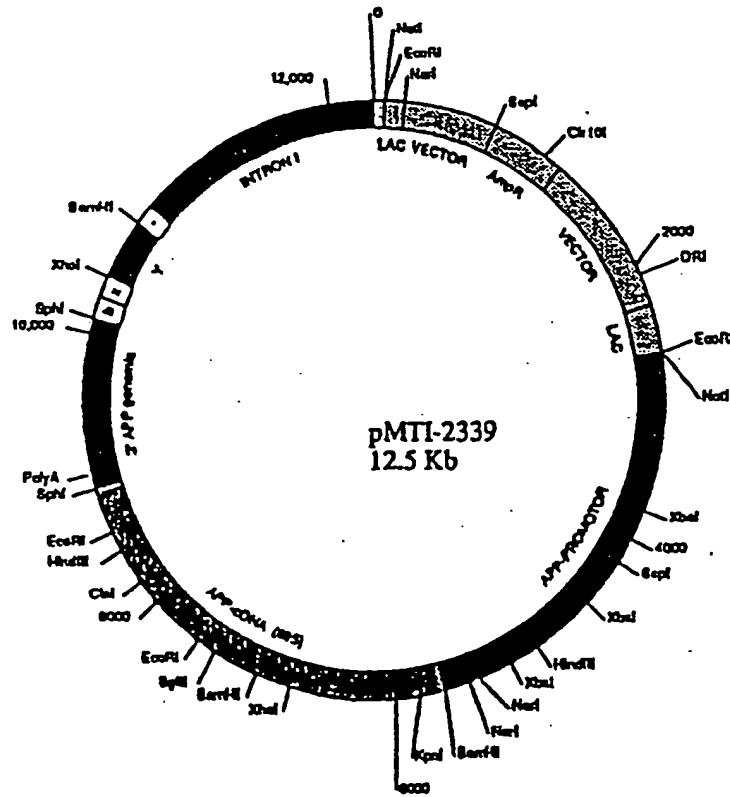


FIG. 15b

3'-End of APP Gene:
DNA Sequence

```

      CATGCCTGG ACAAACCCTT CTTTAAAGAT GTGTCTTCAA TTTGTATAAA
51  ATGGTGTTTT CATGTAATAA AATACATTCT TGGAGGAGCC ACATTGTGCT
101 GGTGTGAATG ATTCCATAGT AACCAATCTG ACCATTIACT GACGTACAGA
151 CCAGTGAGAA GTCTTCGCAT GTTGGGTACC CACACCTGTT GTGTCTAAT
201 TGCAAGTCTG AGTAGGAAGT TGGGGCCAAC ATGTGTCTCC CAGTGTGGG
251 AAAATATTTT ATAGACCTAA TTTACAGTCT TTTACTTGATC TAAACATTT
301 TGCTGCCAAT TTTTGGCCCT CAAGTTTGTC CCAATGAGA GACAAAGGGA
351 AAAGTTCCAG GGAATATAAA ATTAAGACAG CTGATTATCT GTAAGCATG
401 GTTTCTCATC CTGAACGCTA CTAACATTTT GCAGGGATA ATTCTTGT
451 GAAGGGAGTT GTCCTGACCA GTGTAGGATA TTTATTTATT TTATTATGT
501 TTTTGGAGAC GGAGTCTCGC TCTGTACCC AGGCTGGAGT GCAGTGGCAC
551 AATCTCGGCT CACTGCCAAGC TCCGCCTCCC GGGTTCACGC CATCTCTCTG
601 CCTCAGCCTC CTGAATAGCT GGGACTCTAG GTGCCCGCCA CCACGCCCGG
651 CTAATTTTTT GTATTTTLAG TAGAGACGGG GTTTCACCGT GTIAGCCAGG
701 ACAGTCTTGG TCTCCTGACC TCGTGATCTG CCTGCCTCGG CCTCCCAAAG
751 TGCTGAGATT ACAGGCGTGC AAGCCGCGCC CAGCCAGTGC TCTCCTTTA
801 AAAGTAGCCC ATTGGCTGGG CGCAGTGGCT CACGCCTGTA ATCCACGCAC
851 TTTGGGAGCC TGAGGCGGGT GGATCAGGAG GTCAGGAGAT CAAGATATC
901 CTGGCCAATA TGGTGAACC CCATCTCTAC TAAAATACA AAAAAAAAAA
951 AAAAAAAAAA AAGGCCGGGC ATGGTGGCGG GCGCTTGTAG TCCCAGCTAC
1001 TCAGGAGGCT GAGGCAGGAG AATGGTGTCC ACCTGGGAGG CGGAGGTTCC
1051 AGTGAGCTGA GATCGGCCCA CTGCACTCCA GCCTGGGAGA CAGAGCGAGA
1101 CTCGTCTCA ATAAATAAAT AAATAAATA ATAAAAGGAG GGCTGGCAC
1151 GAATGACATG CAGGGAAGGC AGTGAGCAGG TGGAGGTCCC TGTACTCGTT
1201 GTGGTGCCTT ATCTACCAGG CGGTTGAGTT GACGTCTTTG TGCACAGAA
1251 TCGAGCTCGG TACCCGGGGA TCCTCTAGAG TCGACCTGCA GGCATG

```

FIG. 16

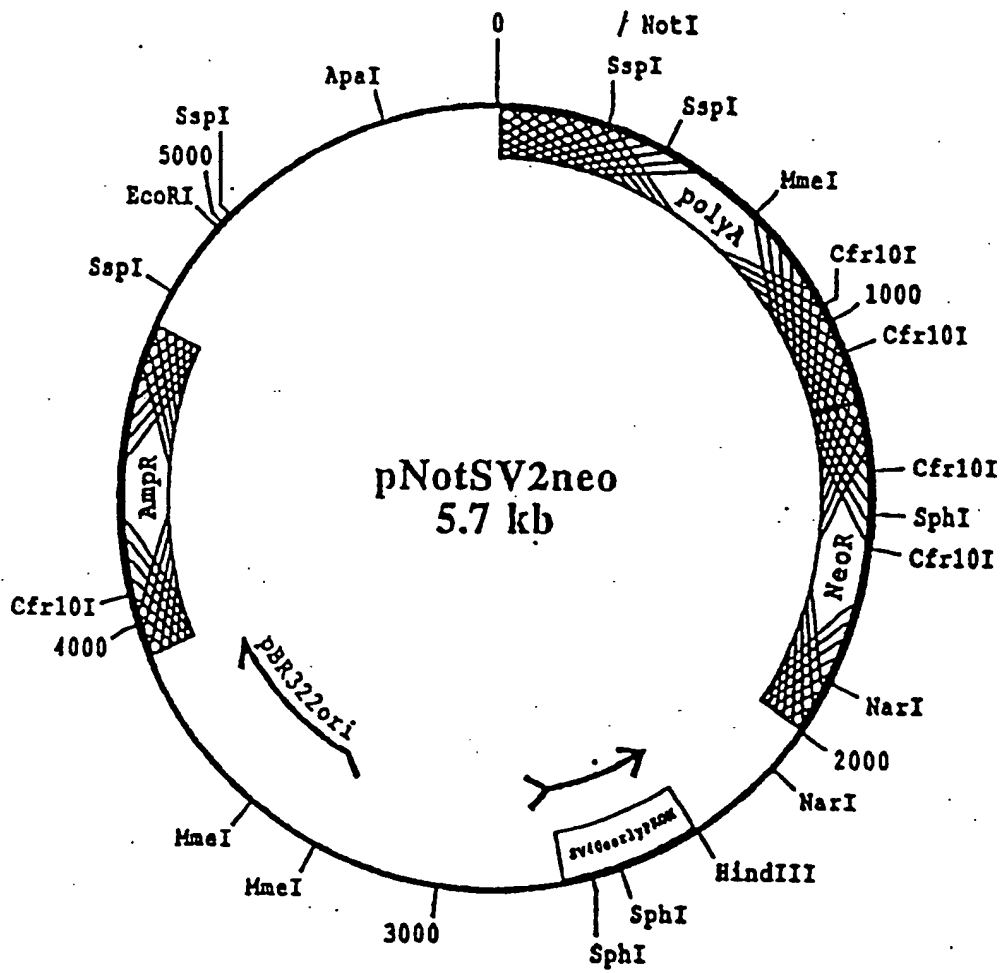


FIG.17

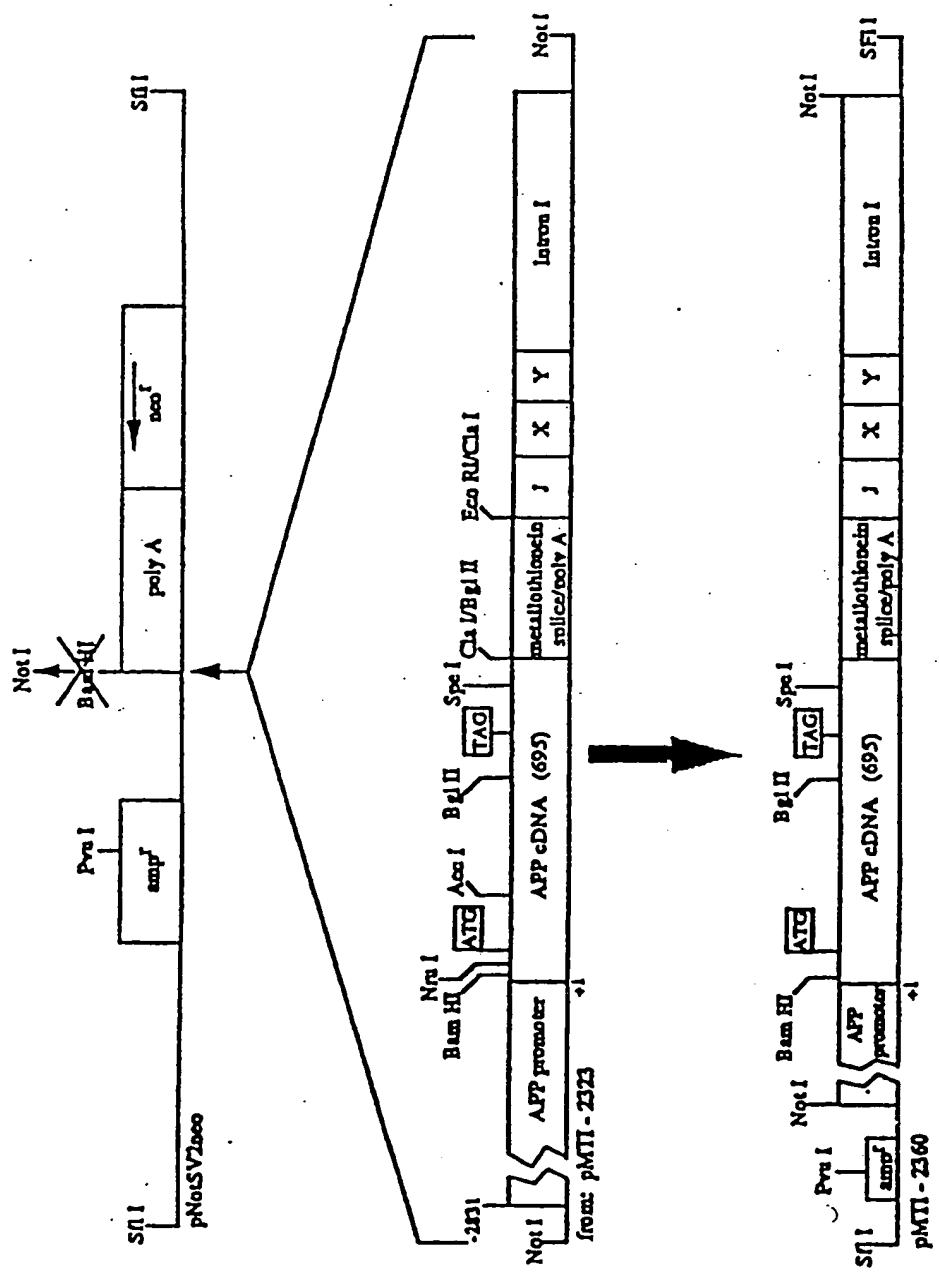


FIG.18a1

Other pNotSV2neo subclones:

- pMTI - 2361 : Not I fragment of pMTI - 2326 in pNotSV2neo
- pMTI - 2362 : Not I fragment of pMTI - 2329 in pNotSV2neo
- pMTI - 2363 : Not I fragment of pMTI - 2331 in pNotSV2neo
- pMTI - 2364 : Not I fragment of pMTI - 2340 in pNotSV2neo
- pMTI - 2365 : Not I fragment of pMTI - 2341 in pNotSV2neo
- pMTI - 2366 : Not I fragment of pMTI - 2337 in pNotSV2neo
- pMTI - 2367 : Not I fragment of pMTI - 2402 in pNotSV2neo
- pMTI - 2368 : Not I fragment of pMTI - 2320 in pNotSV2neo
- pMTI - 2369 : Not I fragment of pMTI - 2339 in pNotSV2neo

FIG.18a2

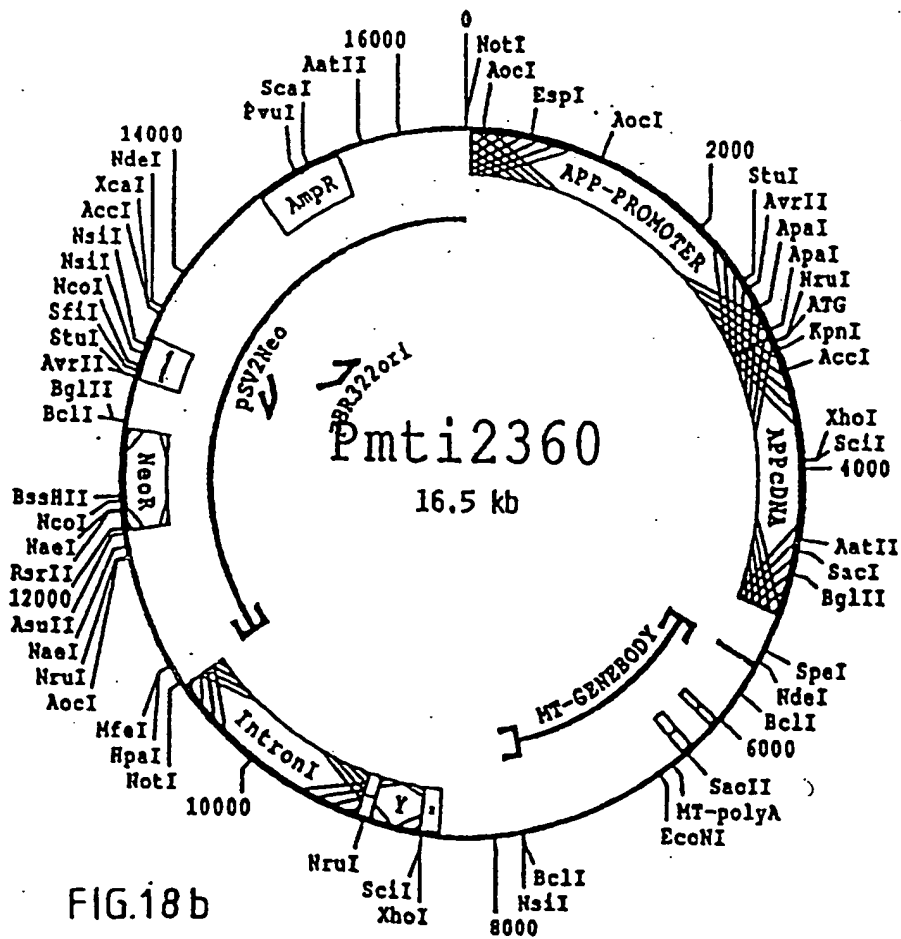
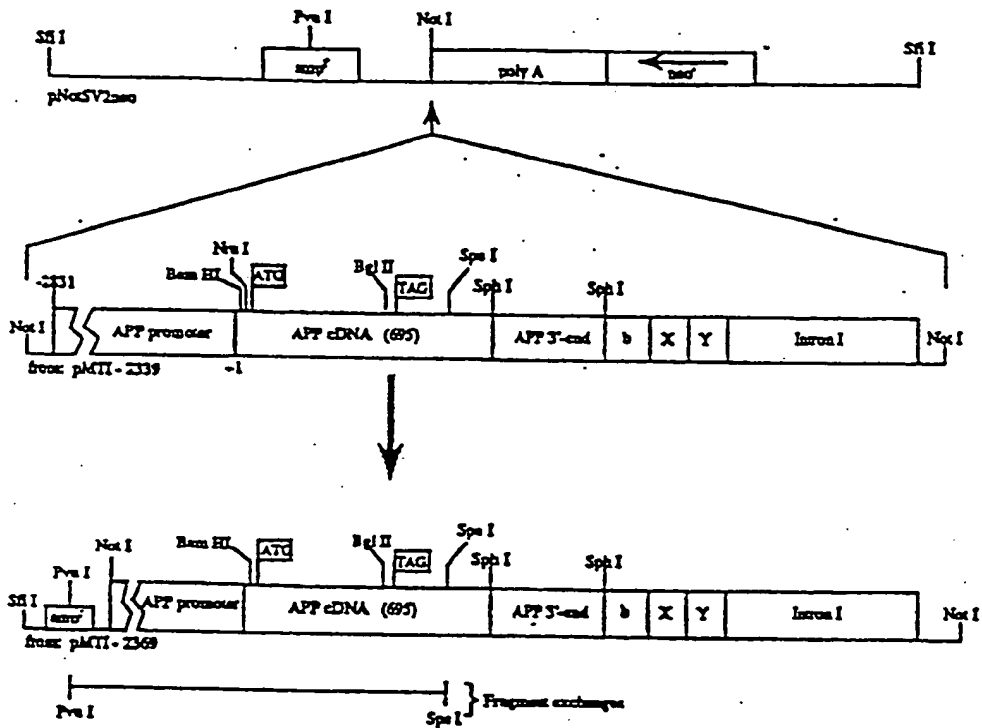


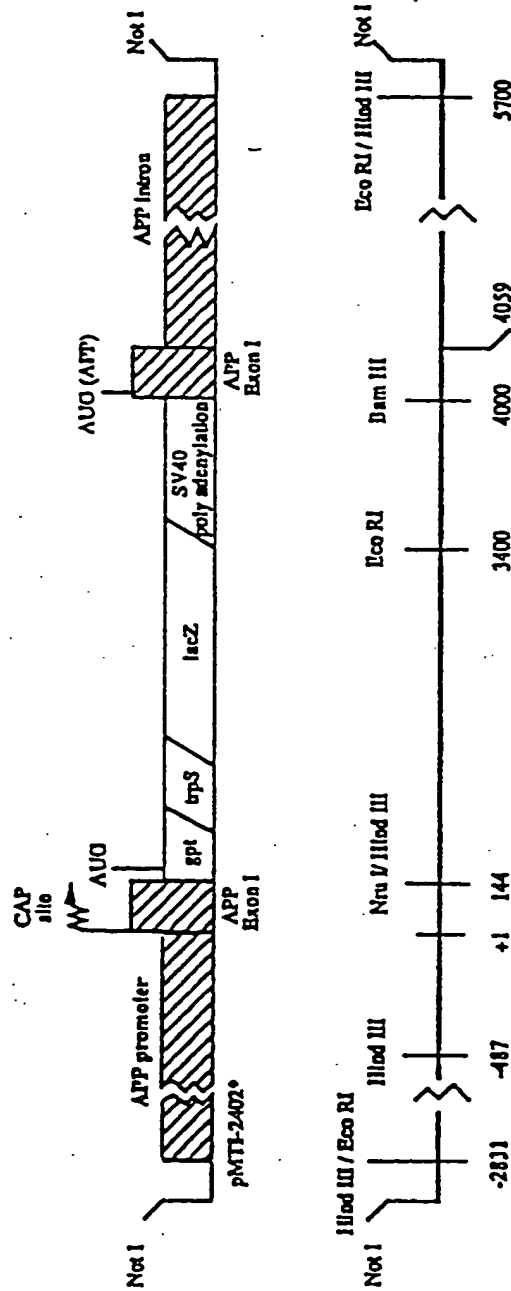
FIG.18b



Alternate Forms:

- pMTI - 2342: exchange of PvuI - SpeI fragment; from pMTI - 2363 to pMTI 2369
- pMTI - 2343: exchange of PvuI - SpeI fragment; from pMTI - 2361 to pMTI - 2369
- pMTI - 2344: exchange of PvuI-SpeI fragment; from pMTI - 2365 to pMTI - 2369

FIG.19



* Vector sequences not shown

FIG.20



FIG. 21 a

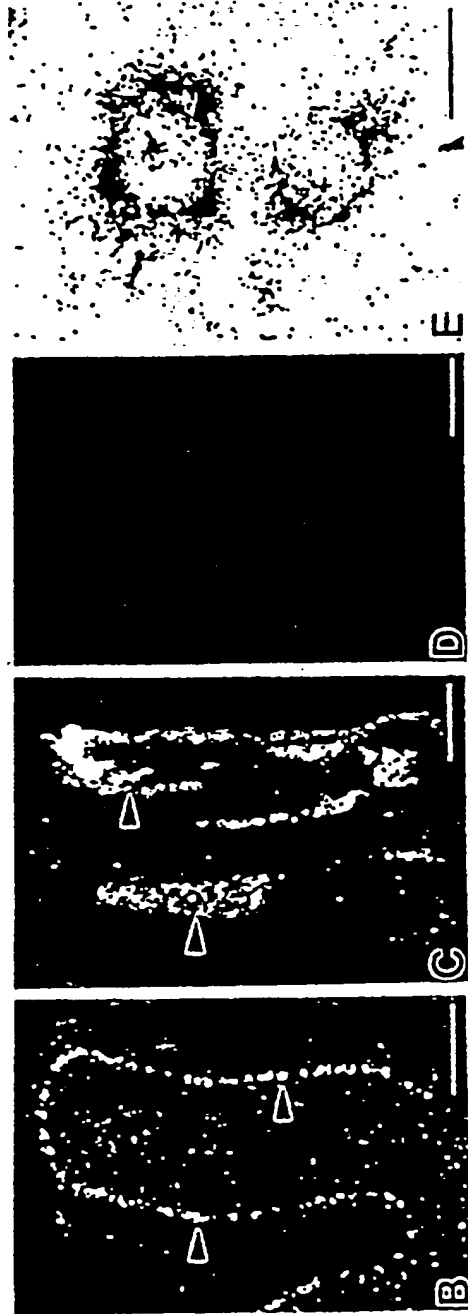


FIG. 21b



FIG. 22

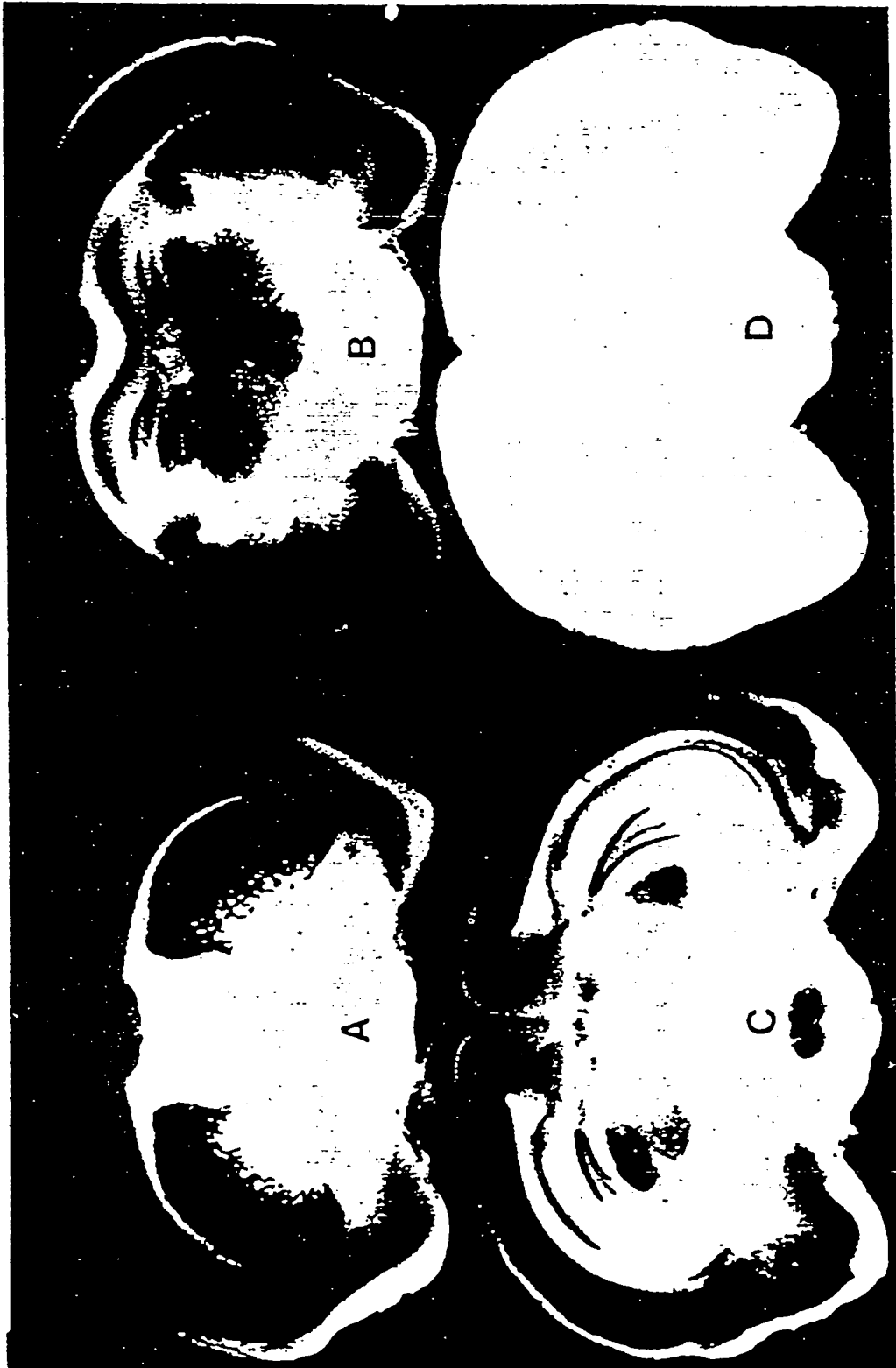


FIG. 23

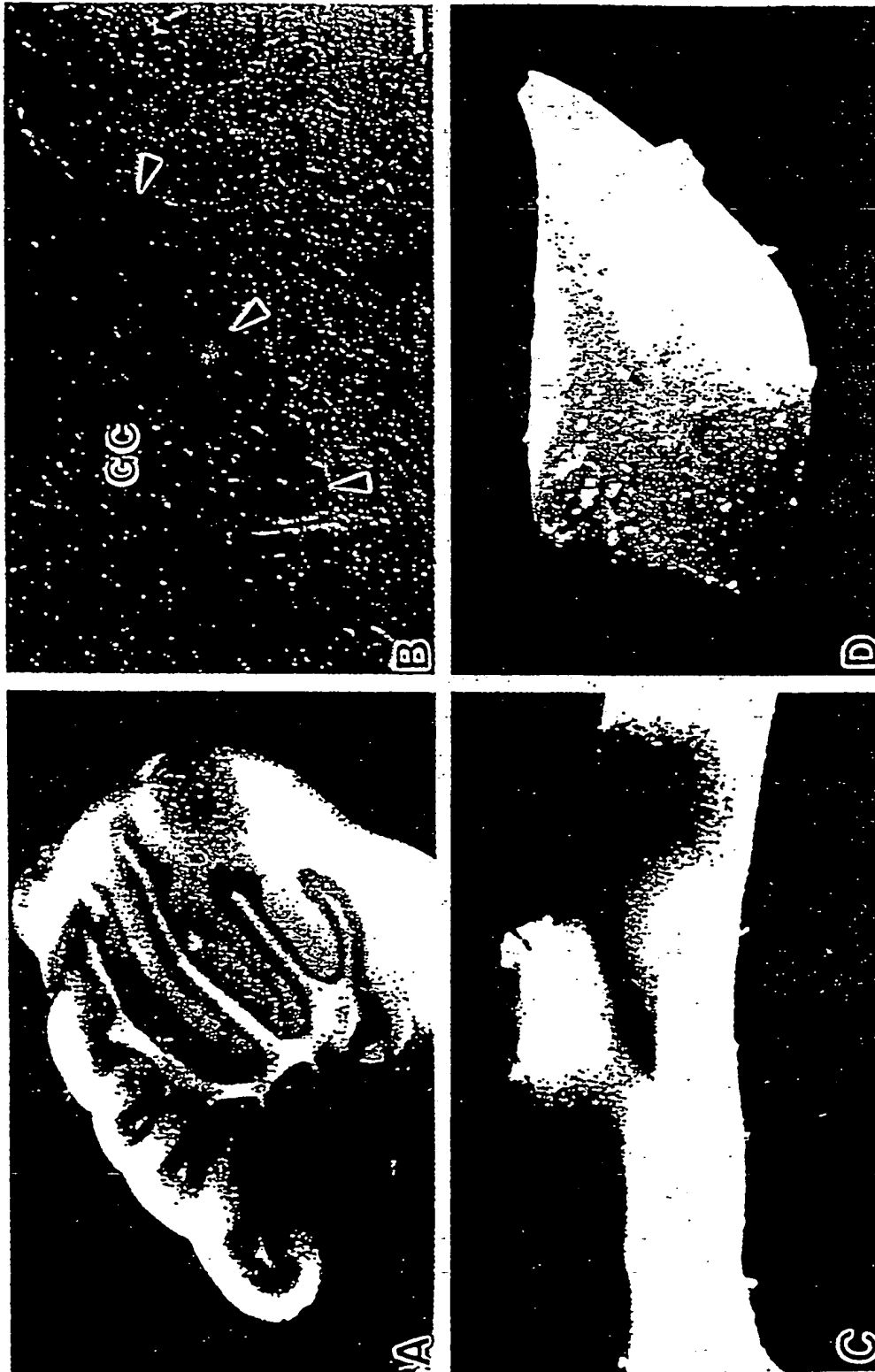


FIG. 24

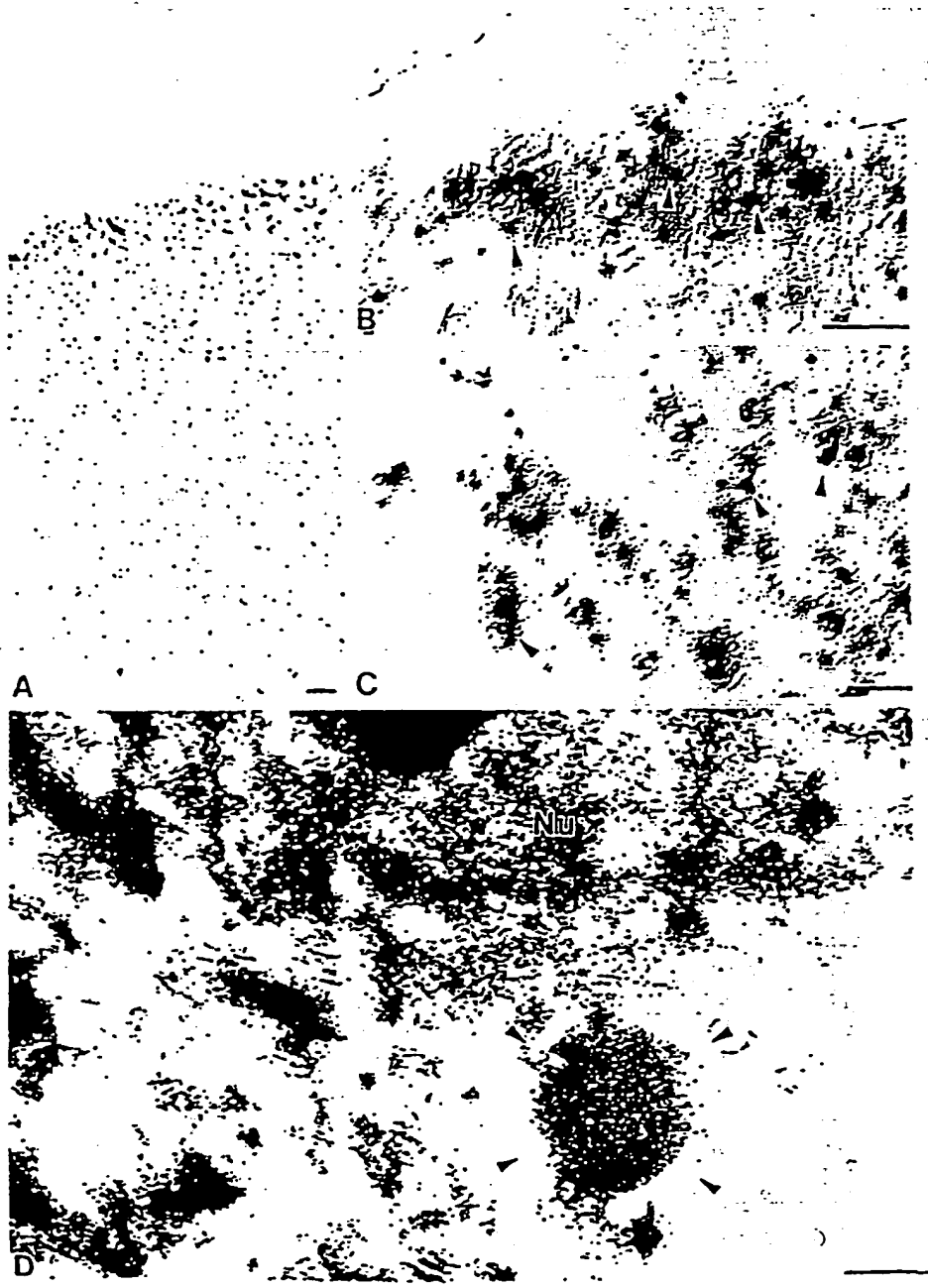


FIG. 25



FIG. 26

Expression of Human APP RNA in Transgenic Mice
S-1 Analysis

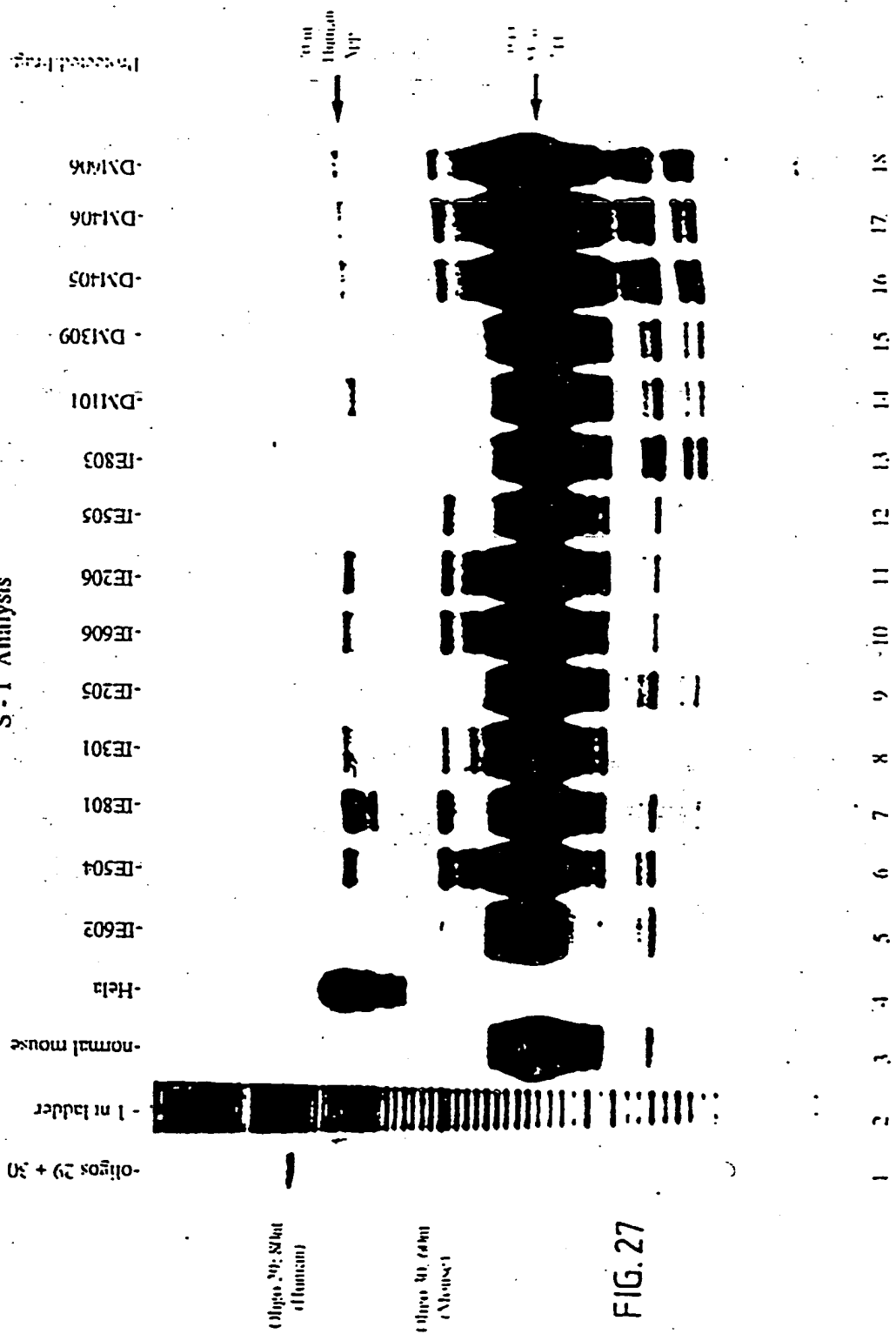


FIG. 27

APP 695, 751, and 770 Expression in Normal Mice & Transgenic
Mice Carrying Human APP Minigenes
Western - blot : MAb 22C-II

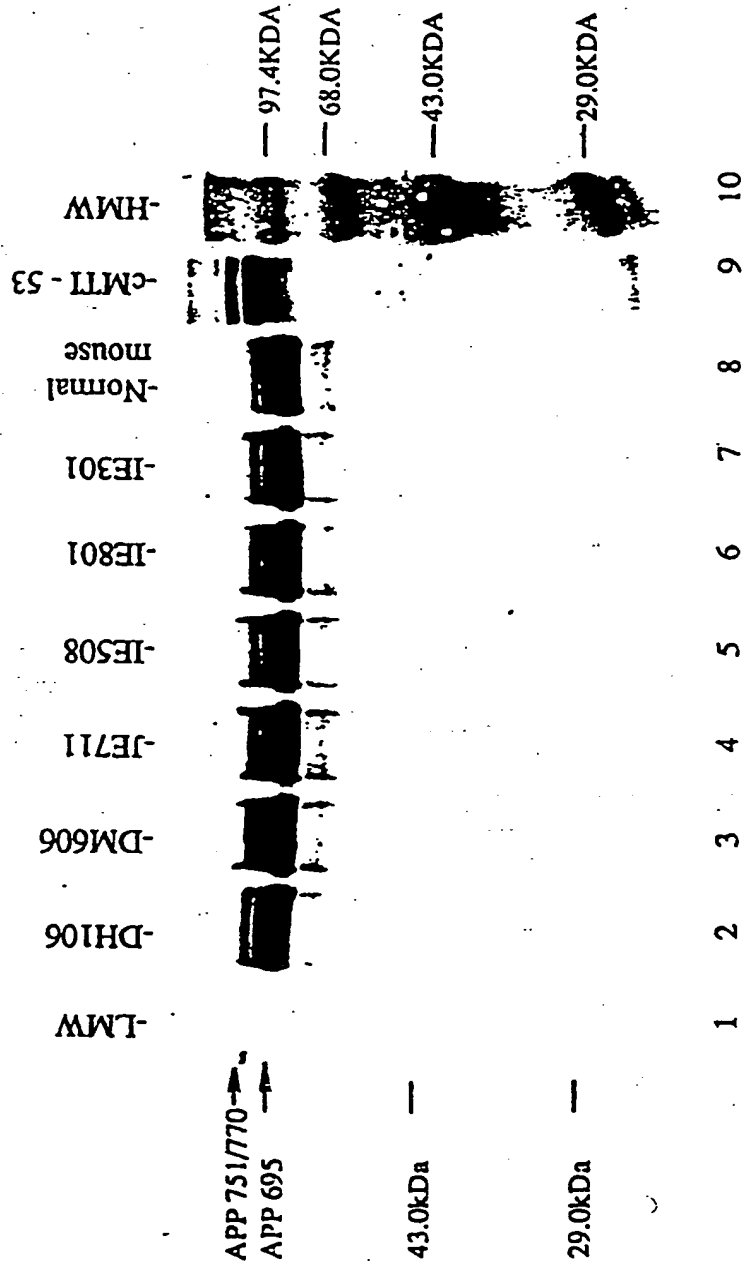


FIG. 28a

Human APP 751 Expression in Transgenic Mice
Carrying Human APP Minigenes
Western - blot : MAb 56 - 1

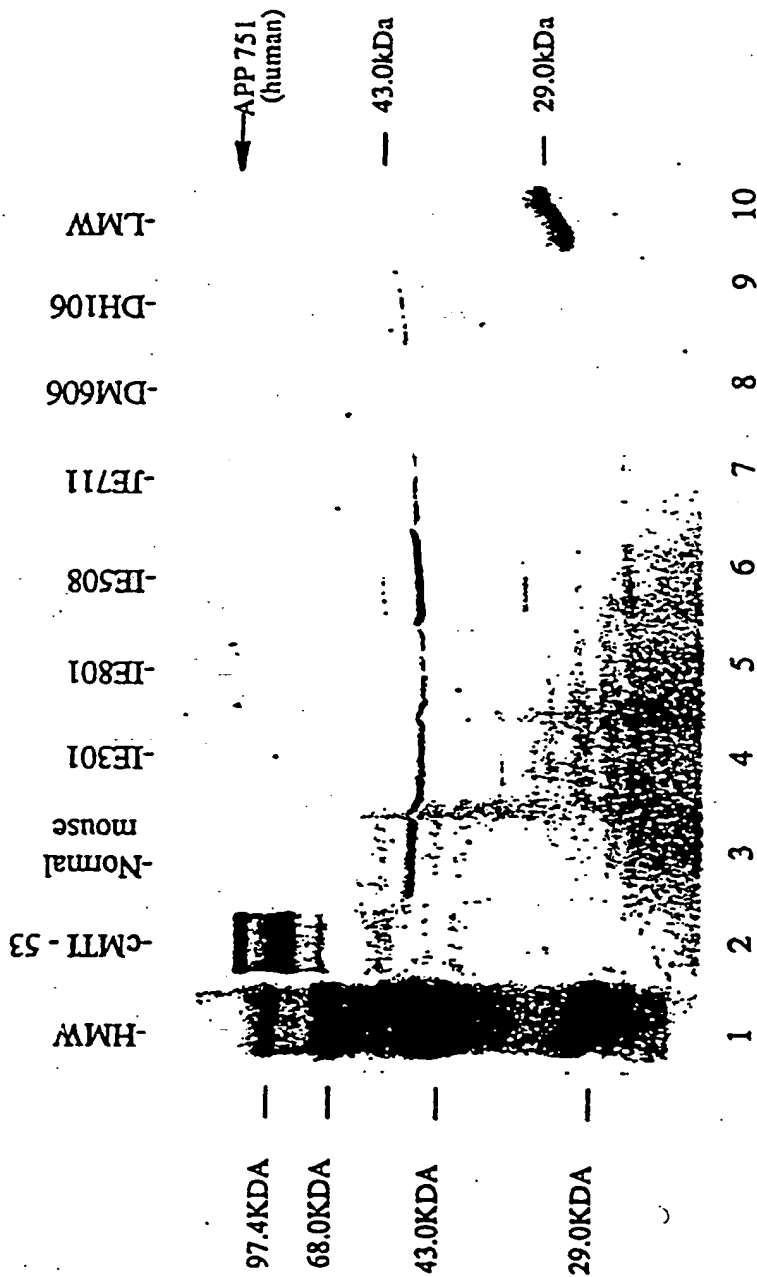


FIG.28b

Human APP Protein Expression :
COS Cell Transfections with APP Minigenes
Western - blot : (MAB 226-II)

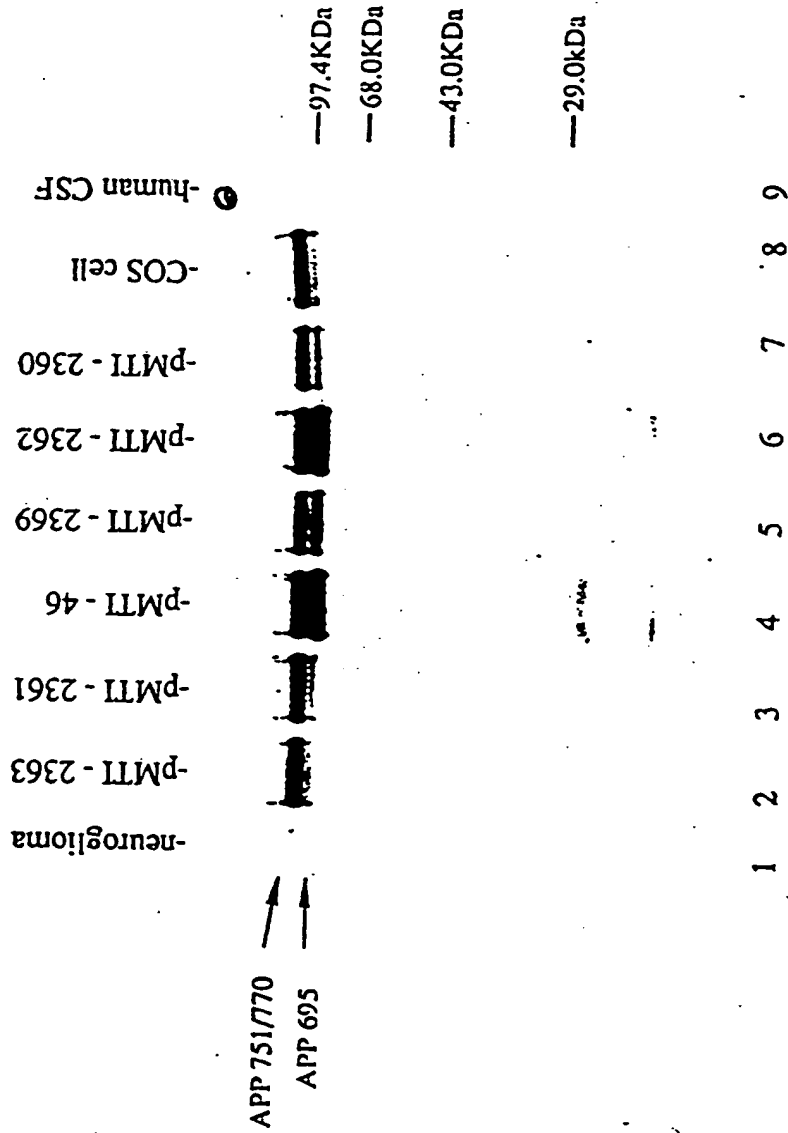


FIG. 29

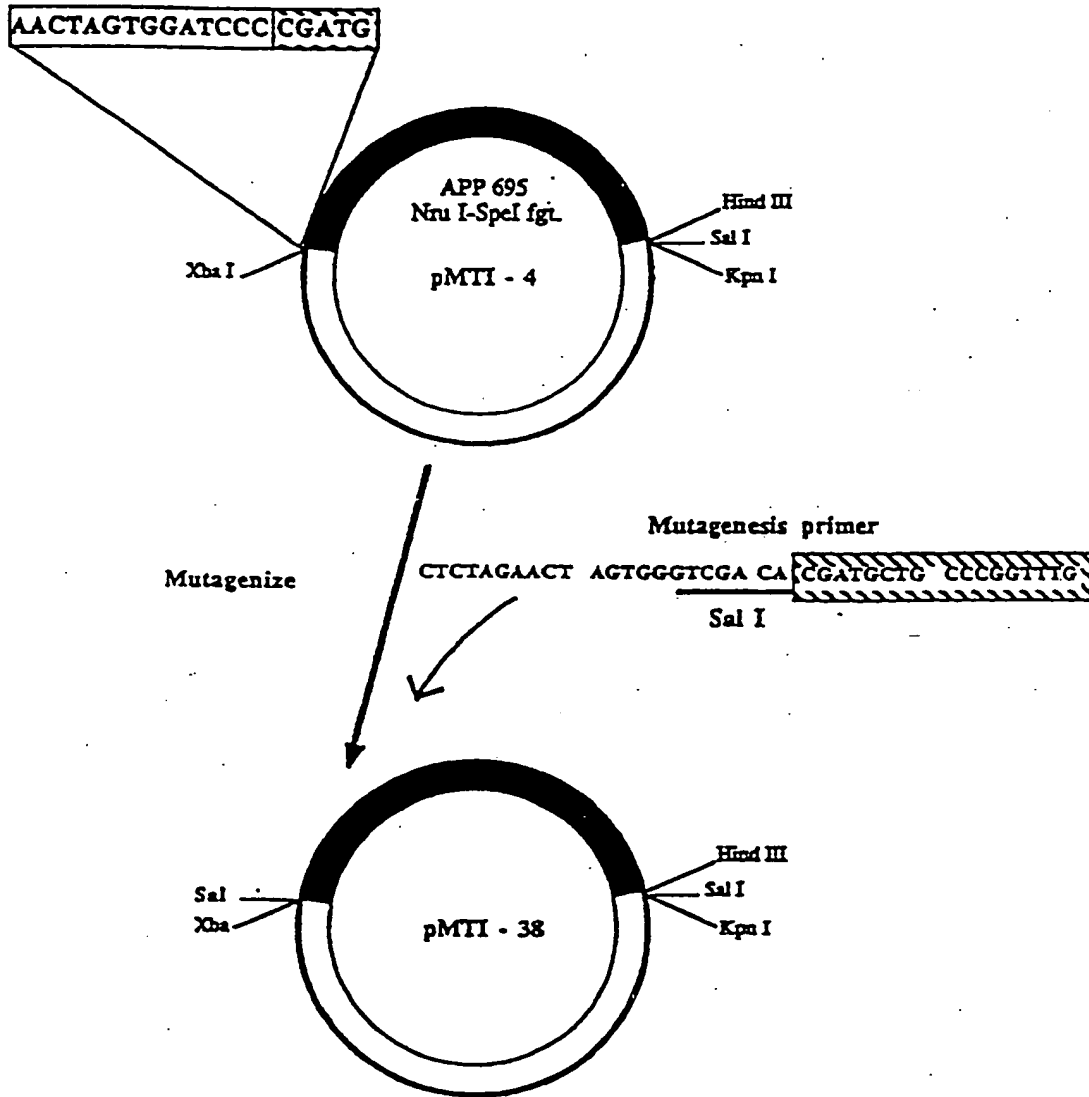


FIG. 30a

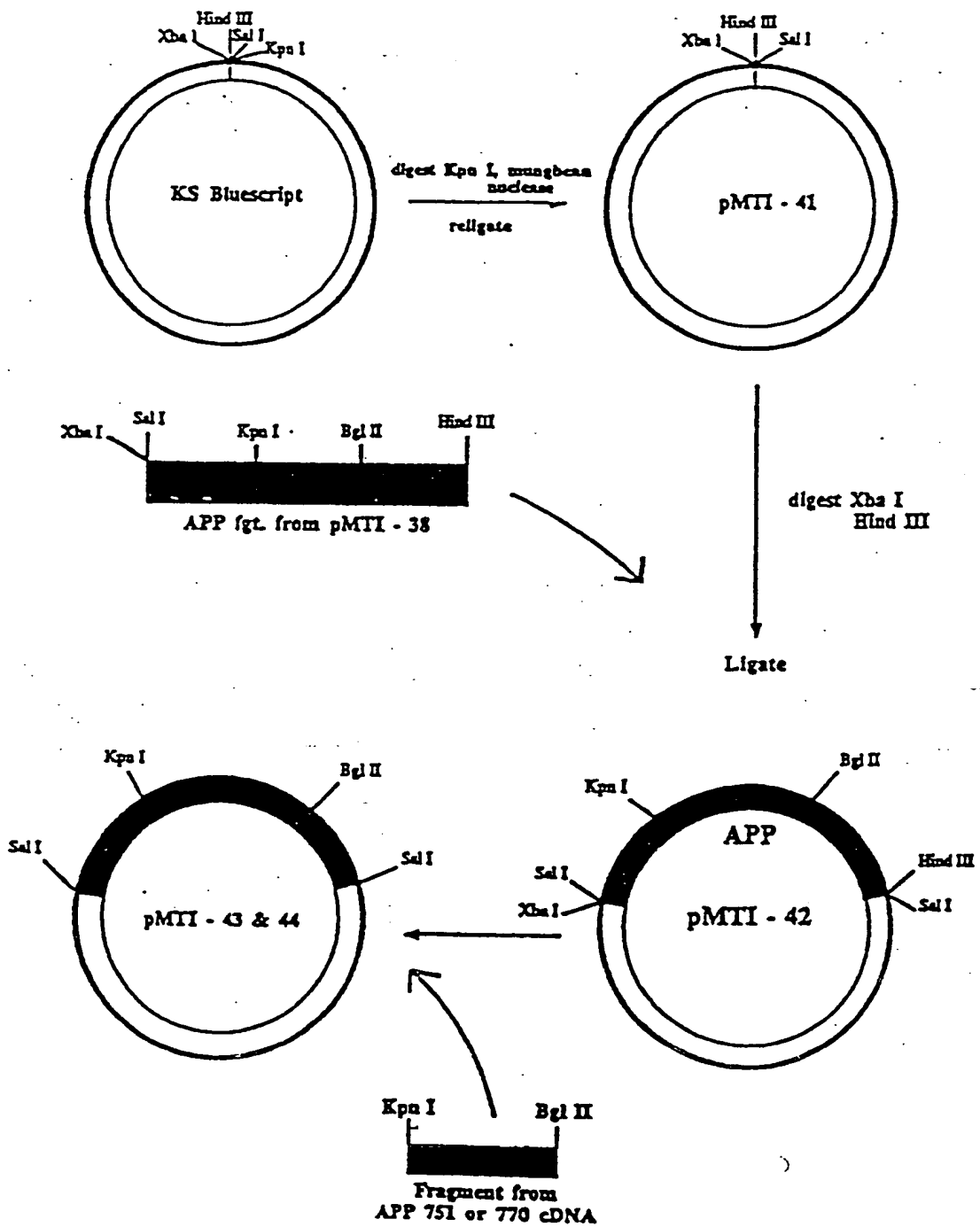


FIG. 30b

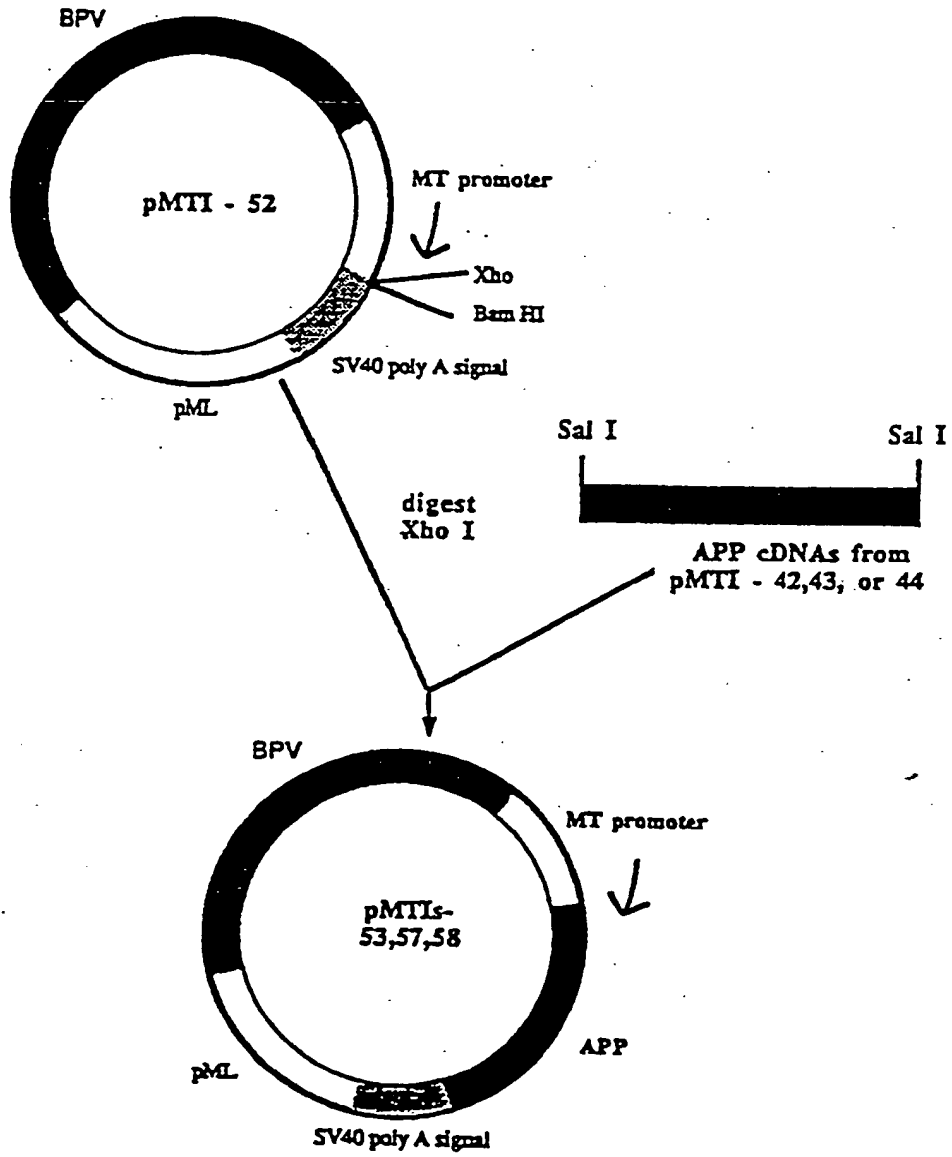
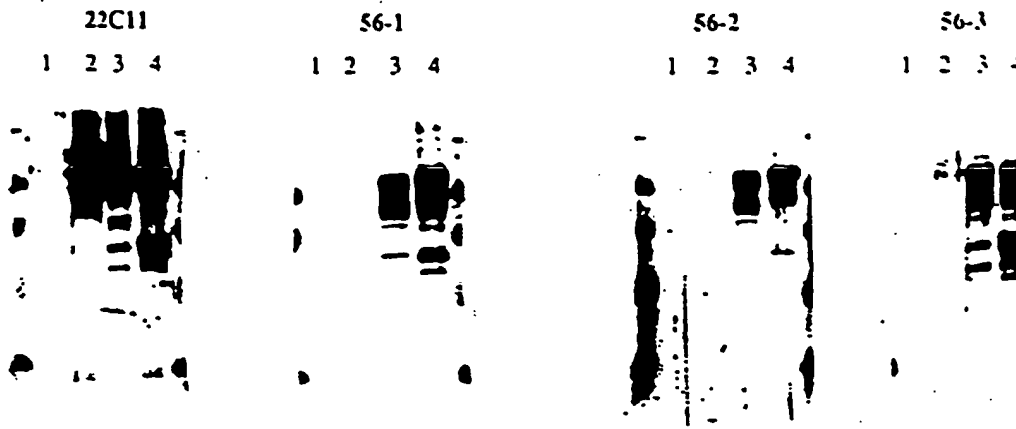


FIG. 31

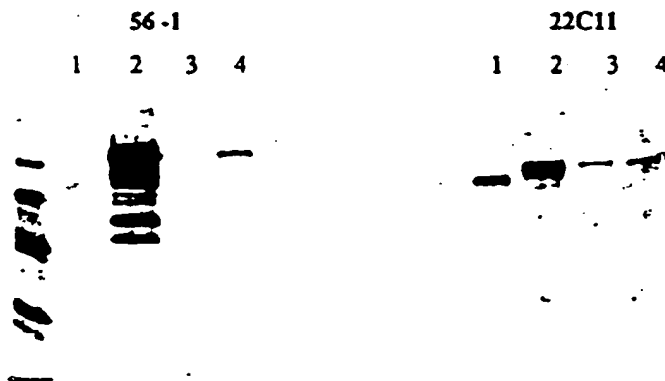
Reaction of 22c11 and Kunitz Monoclonals with APPs



Lane 1 - C127 control; Lane 2, BPV - 695; Lane 3, BPV - 751; Lane 4, BPV - 770.

FIG.32

Primate specificity of 56 - 1



Lane 1 - BPV - 695; Lane 2, BPV - 751; Lane 3, L - cells; Lane 4, cos cells.

FIG.33

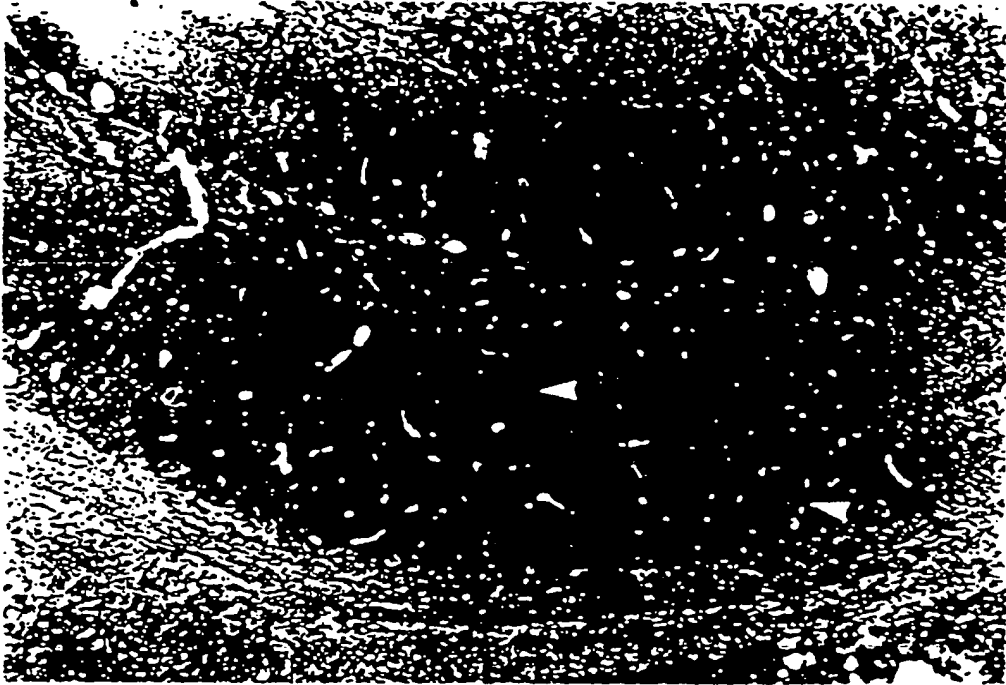


FIG. 34

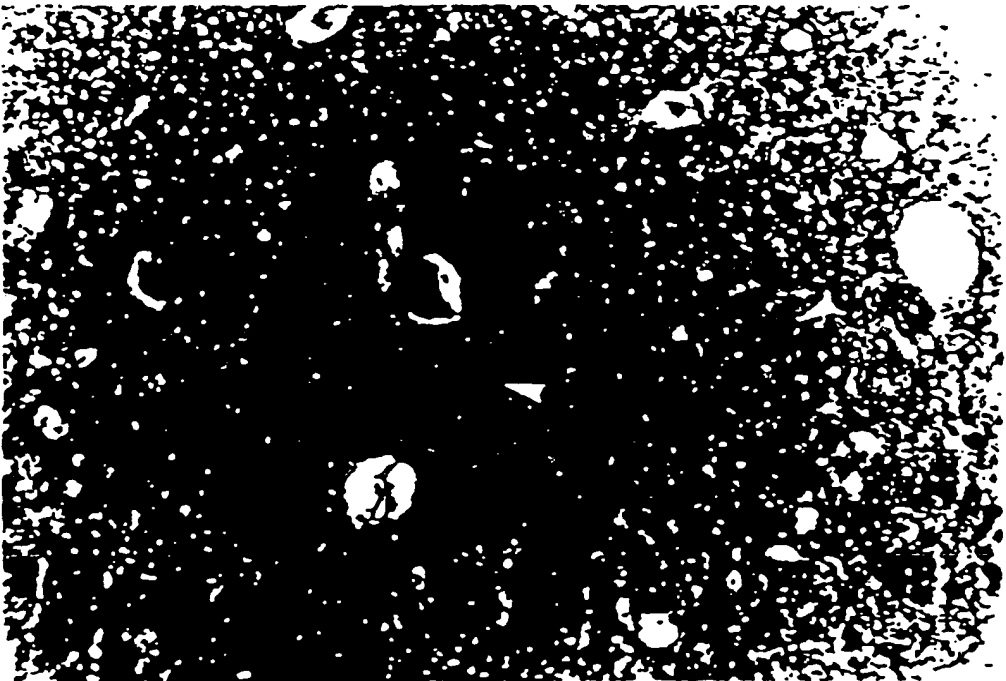


FIG. 35

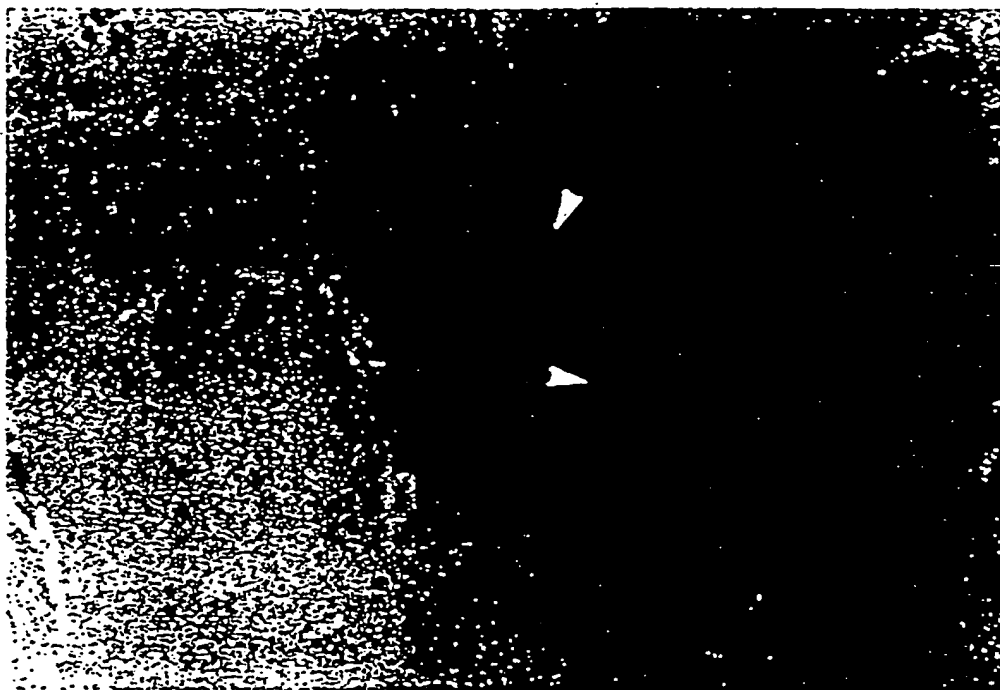


FIG. 36

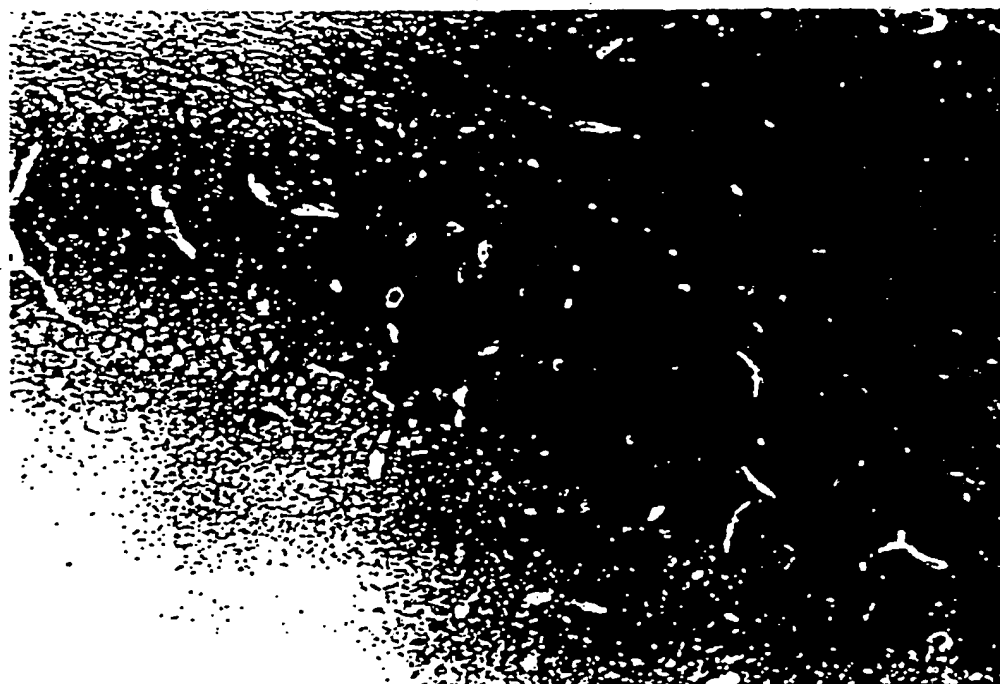


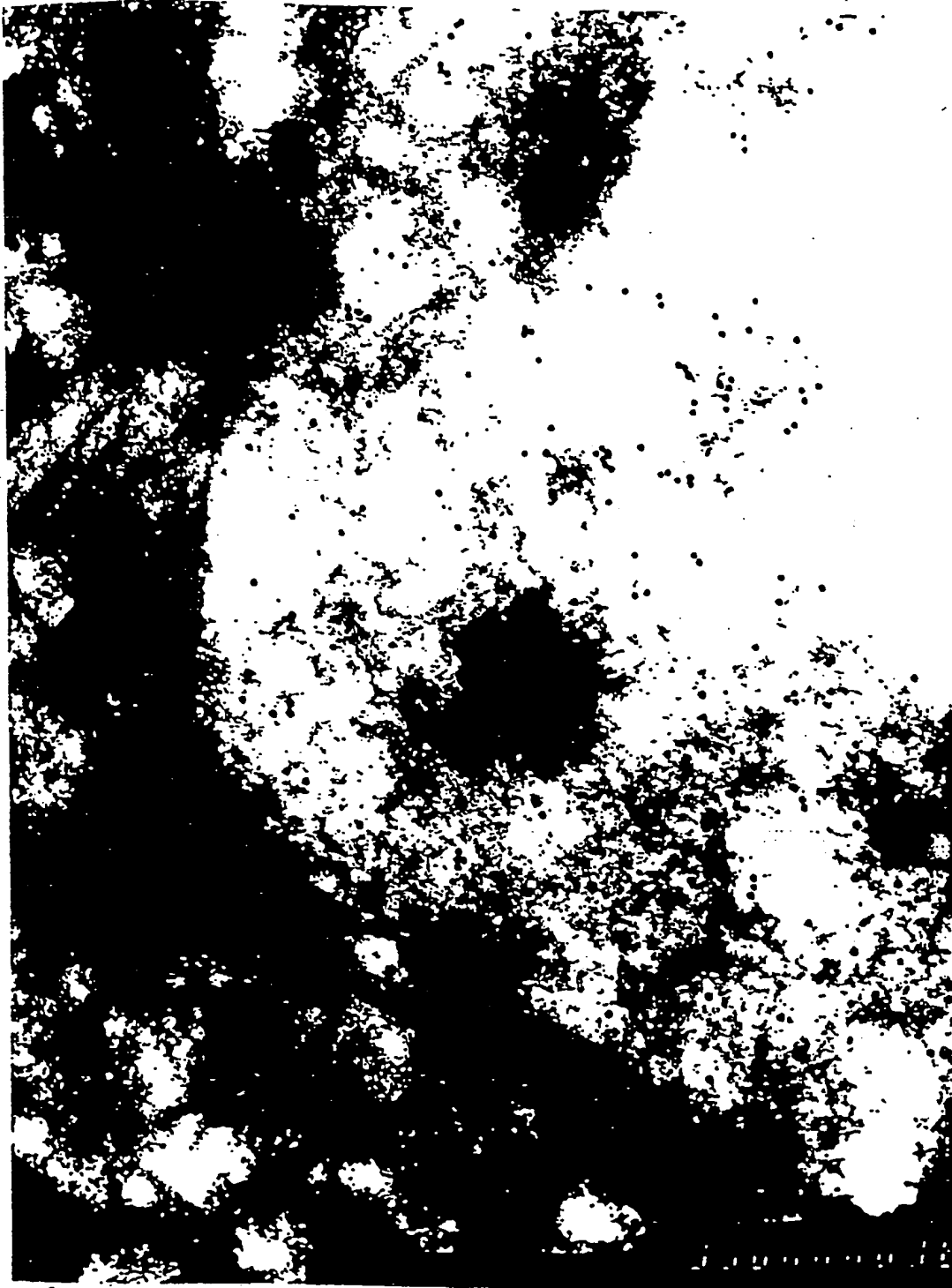
FIG. 37



FIG. 38a

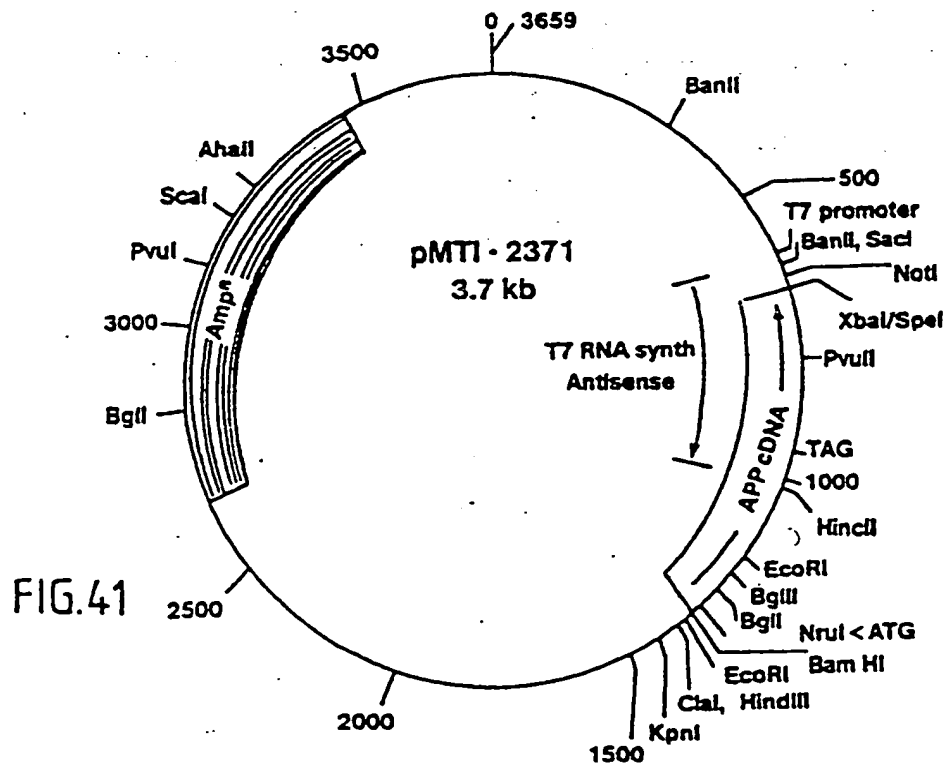
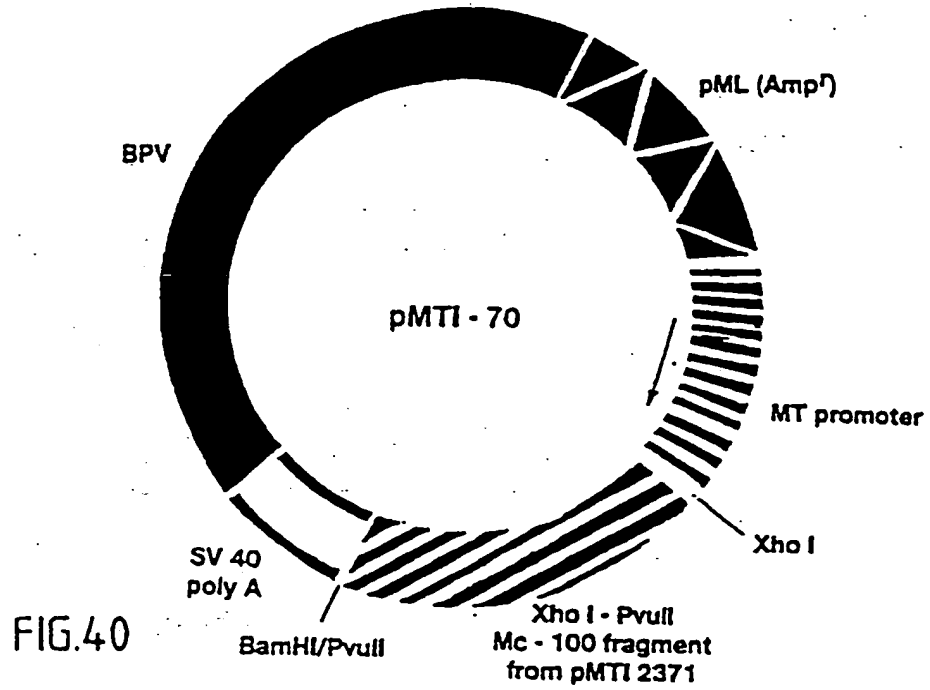


FIG. 38b



90-891.500 Hippocampus

FIG. 39



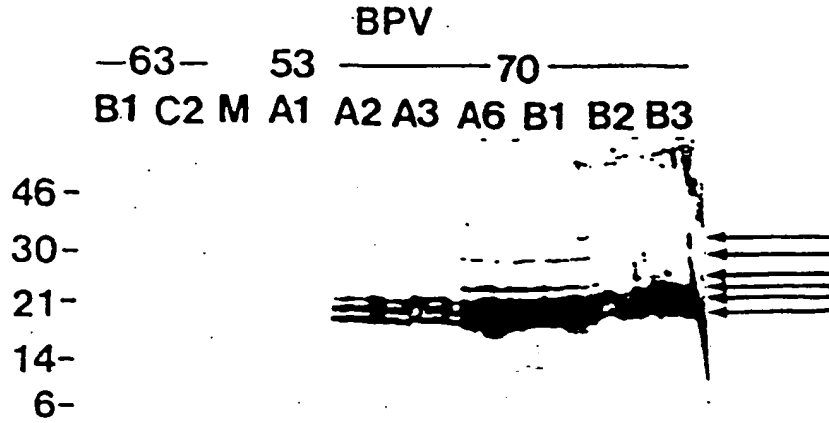


FIG.42

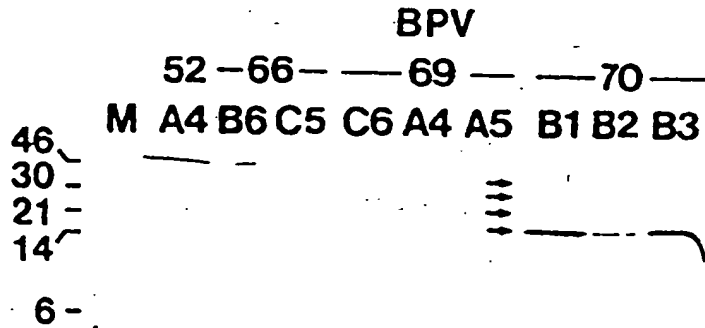


FIG. 43

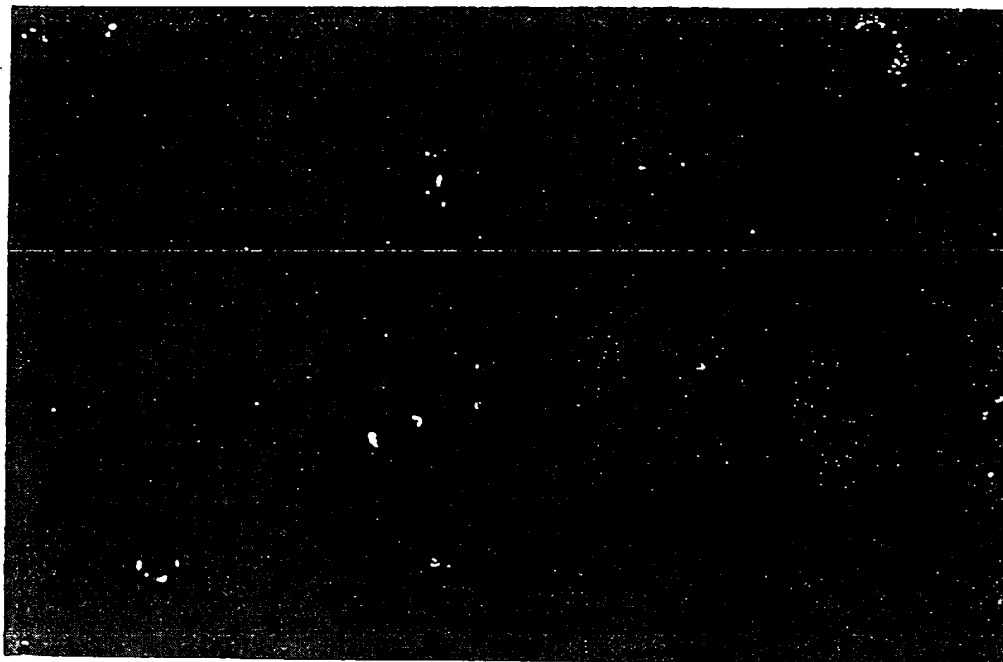


FIG.44a

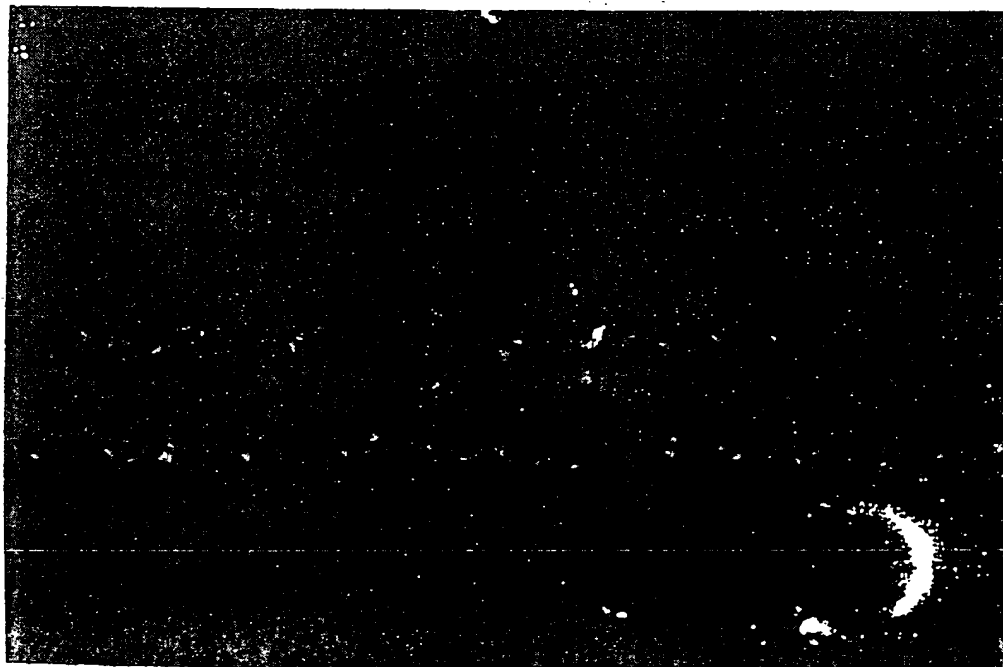


FIG.44b

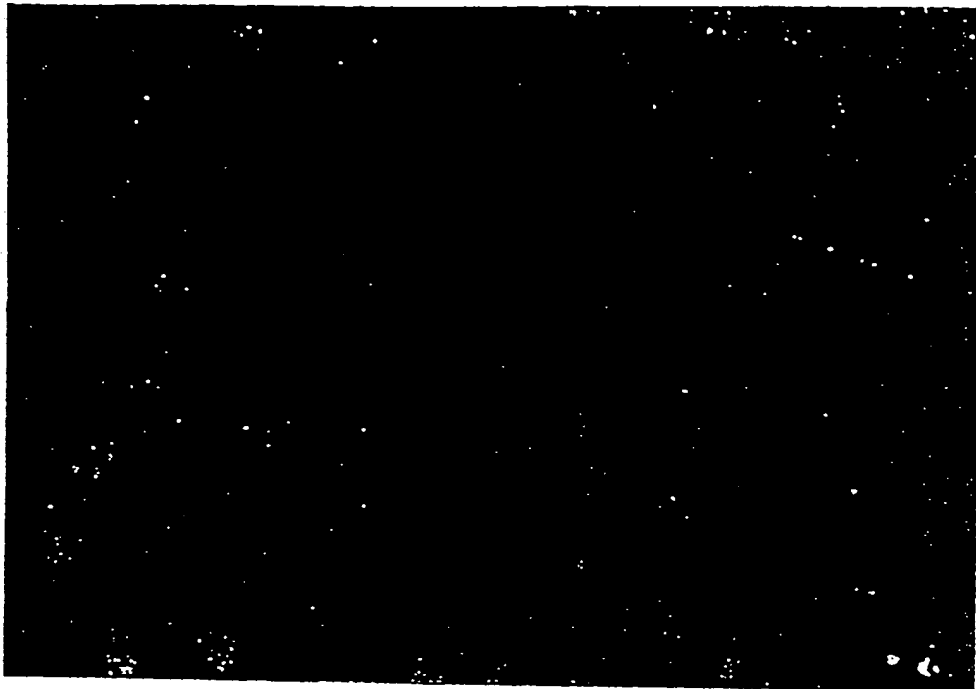


FIG.44c

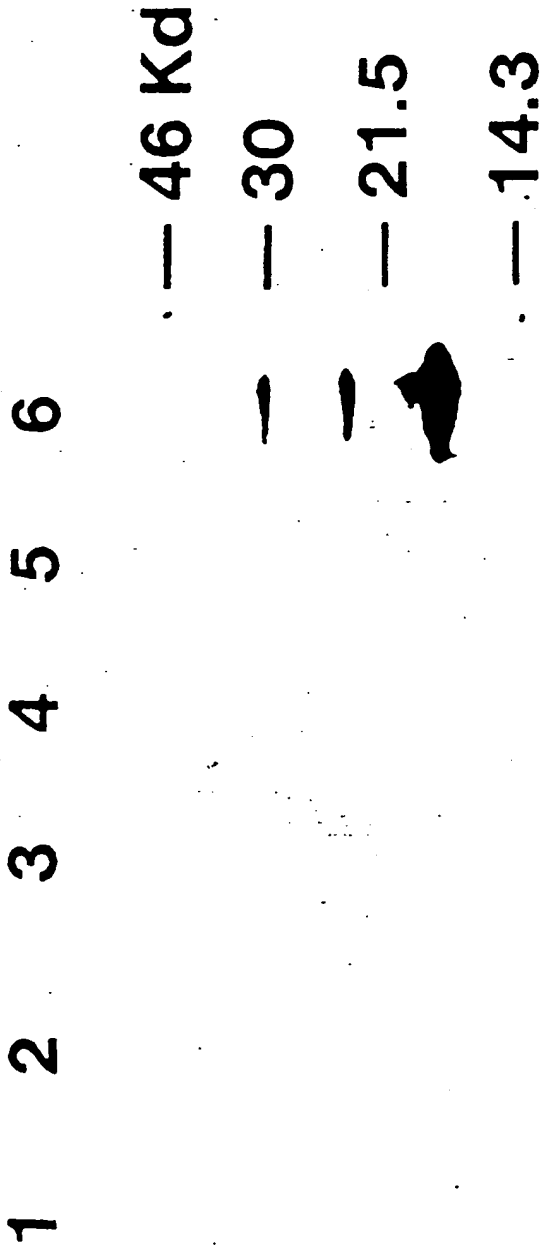


FIG.45

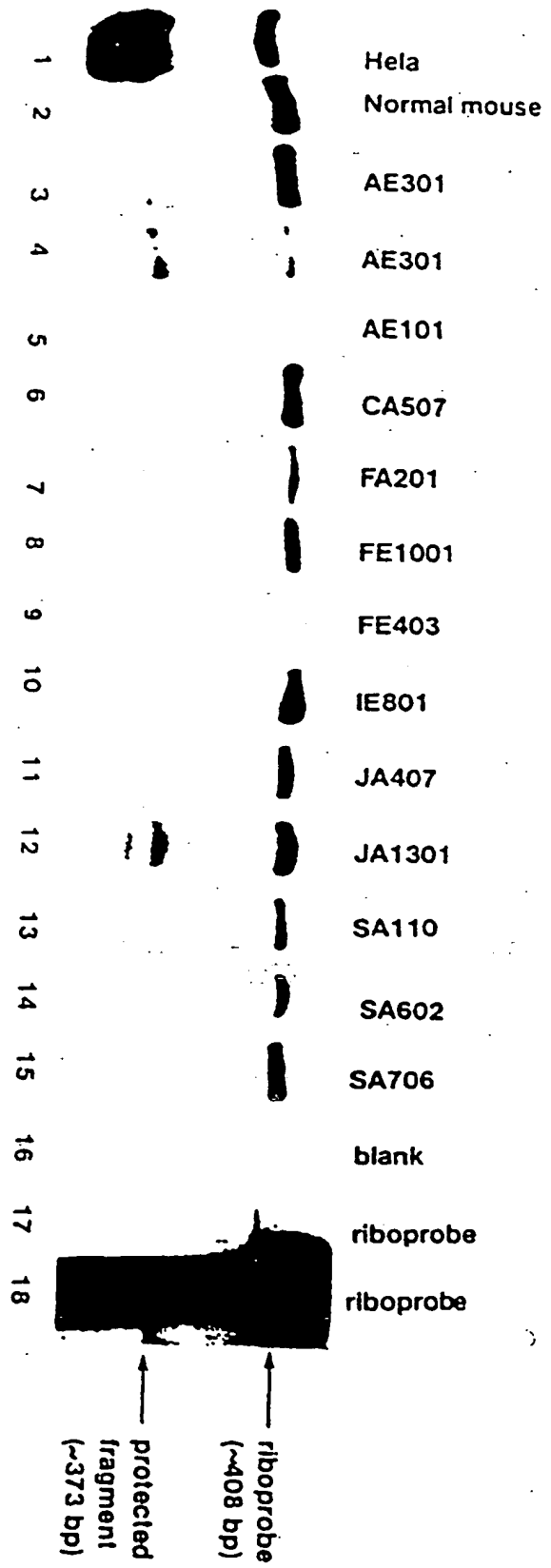


FIG.46



European
Patent Office

EUROPEAN SEARCH
REPORT

Application Number

EP 91 10 5332

DOCUMENTS CONSIDERED TO BE RELEVANT

Category	Citation of document with indication, where appropriate, of relevant passages	Relevant to claim	CLASSIFICATION OF THE APPLICATION (Int. Cl.5)
X	EP-A-0 304 013 (ASAHI KASEI KOGYO K.K.) * whole document; in particular page 5, line 55 - page 6, line 1; page 15, lines 30-36 *	1-10	C 12 N 15/00 C 12 N 15/12
X	WO-A-8 906 693 (THE MCLEAN HOSPITAL CORP. et al.) * whole document *	1-10	
X	WO-A-8 906 689 (THE MCLEAN HOSPITAL CORP. et al.) * whole document *	1-10	
X	J. NEUROPATHOLOGY AND EXP. NEUROLOGY vol. 48, no. 3, May 1989, page 379; B.D. TRAPP et al.: "Expression of the human amyloid precursor protein gene in the CNS of transgenic mice" * abstract *	1-10	
X	J. CELLULAR BIOCHEM. SUPPLEMENT vol. 0, no. 13, part B, 1989, page 185; D.O. WIRAK et al.: "Expression of the human beta-amyloid precursor gene in transgenic mice" * abstract *	1-4,8,9	
X	BEHAVIOR GENETICS vol. 19, no. 6, November 1989, pages 771,772; M.L. OSTER-GRANITE et al.: "Recent studies of mice transgenic for the gene encoding amyloid precursor protein" * abstract *	1,2,4,8,9	TECHNICAL FIELDS SEARCHED (Int. Cl.5)
X	BIOCHEMICAL AND BIOPHYSICAL RESEARCH COMMUNICATIONS vol. 159, no. 1, 28 February 1989, pages 297-304; G. LA FAUCI et al.: "Characterization of the 5'-end region and the first two exons of the beta-protein precursor gene" * whole article *	1,2,5	C 12 N 15/00 C 12 N 15/12 C 07 K 15/00

The present search report has been drawn up for all claims

Place of search Berlin	Date of completion of search 25 June 91	Examiner JULIA P.
---------------------------	--	----------------------

CATEGORY OF CITED DOCUMENTS
 X: particularly relevant if taken alone
 Y: particularly relevant if combined with another document of the same category
 A: technological background
 O: non-written disclosure
 P: intermediate document
 T: theory or principle underlying the invention

E: earlier patent document, but published on, or after the filing date
 D: document cited in the application
 L: document cited for other reasons
 &: member of the same patent family, corresponding document



European
Patent Office

EUROPEAN SEARCH REPORT

Application Number

EP 91 10 5332

DOCUMENTS CONSIDERED TO BE RELEVANT			
Category	Citation of document with indication, where appropriate, of relevant passages	Relevant to claim	CLASSIFICATION OF THE APPLICATION (Int. Cl.5)
X	THE EMBO JOURNAL vol. 7, no. 9, 1988, pages 2807-2813, Oxford, GB; J.M. SALBAUM et al.: "The promoter of Alzheimer's disease amyloid A4 precursor gene" * whole article *	1,2,5	
X	J. CELLULAR BIOCHEM. SUPPLEMENT vol. 0, no. 13, part C, 1989, page 145; A.J. UNTERBECK et al.: "Tissue specificities and developmental patterns of human beta-amyloid gene expression" * abstract *	1,2,4,8,9	
P,X	DATABASE WPI/DERWENT abstract no. 91-089452 (13), 1991, Derwent Publications Ltd., London, GB; & JP - A - 3004794 (MOLECULAR THERAPEUT.) 10.01.1991 * abstract *	1,2,4-6,8,9	
P,X	EP-A-0 375 406 (THE TRUSTEES OF THE UNIVERSITY OF PENNSYLVANIA) * abstract; page 12, lines 25-40; page 15, lines 7-25; claim 29 *	1-4,7-10	
P,X	WO-A-9 009 441 (THE GENERAL HOSPITAL CORP.) * whole document; in particular page 5, line 18; page 20, lines 21-23 *	1,3-7	
A	WO-A-8 703 904 (BOEHRINGER MANNHEIM GMBH) * whole document *	3,7	TECHNICAL FIELDS SEARCHED (Int. Cl.5)
The present search report has been drawn up for all claims			
Place of search	Date of completion of search	Examiner	
Berlin	25 June 91	JULIA P.	
<p style="text-align: center;">CATEGORY OF CITED DOCUMENTS</p> <p>X: particularly relevant if taken alone Y: particularly relevant if combined with another document of the same category A: technological background O: non-written disclosure P: intermediate document T: theory or principle underlying the invention</p> <p style="text-align: right;">E: earlier patent document, but published on, or after the filing date D: document cited in the application L: document cited for other reasons</p> <p style="text-align: right;">&: member of the same patent family, corresponding document</p>			



DOCUMENTS CONSIDERED TO BE RELEVANT			
Category	Citation of document with indication, where appropriate, of relevant passages	Relevant to claim	CLASSIFICATION OF THE APPLICATION (Int. Cl.5)
P,X	NEUROBIOLOGY OF AGING vol. 11, no. 3, 1990, page 326; J. BEER et al.: "Transgenic mice and Alzheimer's disease" * abstract *	1,4,8,9	
P,X	J. CELLULAR BIOCHEM. SUPPLEMENT vol. 0, no. 14, part F, 1990, page 66; N. FOX et al.: "Differential expression of a human amyloid beta protein-cat fusion gene in transgenic mice" * abstract *	1,5	
			TECHNICAL FIELDS SEARCHED (Int. Cl.5)
The present search report has been drawn up for all claims			
Place of search Berlin		Date of completion of search 25 June 91	Examiner JULIA P.
<p>CATEGORY OF CITED DOCUMENTS</p> <p>X: particularly relevant if taken alone Y: particularly relevant if combined with another document of the same category A: technological background O: non-written disclosure P: intermediate document T: theory or principle underlying the invention</p> <p>E: earlier patent document, but published on, or after the filing date D: document cited in the application L: document cited for other reasons</p> <p>&: member of the same patent family, corresponding document</p>			